

## CITY OF HERMOSA BEACH

### CONSTRUCTION CONTRACT PW-PC-25-016

#### Emergency Storm Drainpipe and Sinkhole Repair on Valley Drive

#### 1. PARTIES AND DATE.

This Contract is made and entered into this 28th day of July, 2025 by and between the City of Hermosa Beach, a public agency of the State of California ("City") and Grbcon, Incorporated, a California corporation with its principal place of business at [5114 Elton Street, Baldwin Park, CA 91706] ("Contractor"). City and Contractor are sometimes individually referred to as "Party" and collectively as "Parties" in this Contract.

#### 2. RECITALS.

2.1 City. City is a public agency organized under the laws of the State of California, with power to contract for services necessary to achieve its purpose.

2.2 Contractor. Contractor desires to perform and assume responsibility for the provision of certain construction services required by the City on the terms and conditions set forth in this Contract. Contractor represents that it is duly licensed and experienced in providing roadway related construction services and related electrical construction services to public clients, that it and its employees or subcontractors have all necessary licenses and permits to perform the services in the State of California, and that it is familiar with the plans of City. The following license classifications are required for this Project: **A**.

2.3 Project. City desires to engage Contractor to render such services for the Emergency Storm Drainpipe and Sinkhole Repair on Valley Drive ("Project") as set forth in this Contract.

2.4 Project Documents & Certifications. Contractor has obtained, and delivers concurrently herewith, a performance bond, a payment bond, and all insurance documentation, as required by the Contract.

#### 3. TERMS

3.1 Incorporation of Documents. This Contract includes and hereby incorporates in full by reference the following documents, including all exhibits, drawings, specifications and documents therein, and attachments and addenda thereto:

- Services/Schedule (Exhibit "A")
- Plans and Specifications (Exhibit "B")
- Special Conditions (Exhibit "C")
- Contractor's Certificate Regarding Workers' Compensation (Exhibit "D")
- Public Works Contractor Registration Certification (Exhibit "E")
- Fleet Compliance Certification (Exhibit "F")
- Change Orders executed by the City
- Latest Edition of the Standard Specifications for Public Works Construction (The Greenbook), Excluding Sections 1-9

3.2 Contractor's Basic Obligation; Scope of Work. Contractor promises and agrees, at its own cost and expense, to furnish to the City all labor, materials, tools, equipment, services, and incidental and customary work necessary to fully and adequately complete the Project, including all structures and facilities necessary for the Project or described in the Contract (hereinafter sometimes referred to as the "Work"), for a Total Contract Price as specified pursuant to this Contract. All Work shall be subject to, and performed in accordance with the above referenced documents, as well as the exhibits attached hereto and incorporated herein by reference. The plans and specifications for the Work are further described in Exhibit "B" attached hereto and incorporated herein by this reference. Special Conditions, if any, relating to the Work are described in Exhibit "C" attached hereto and incorporated herein by this reference.

3.2.1 Change in Scope of Work. Any change in the scope of the Work, method of performance, nature of materials or price thereof, or any other matter materially affecting the performance or nature of the Work shall not be paid for or accepted unless such change, addition or deletion is approved in writing by a valid change order executed by the City. Should Contractor request a change order due to unforeseen circumstances affecting the performance of the Work, such request shall be made within five (5) business days of the date such circumstances are discovered or shall waive its right to request a change order due to such circumstances. If the Parties cannot agree on any change in price required by such change in the Work, the City may direct the Contractor to proceed with the performance of the change on a time and materials basis.

3.2.2 Substitutions/"Or Equal". Pursuant to Public Contract Code Section 3400(b), the City may make a finding that designates certain products, things, or services by specific brand or trade name. Unless specifically designated in this Contract, whenever any material, process, or article is indicated or specified by grade, patent, or proprietary name or by name of manufacturer, such Specifications shall be deemed to be used for the purpose of facilitating the description of the material, process or article desired and shall be deemed to be followed by the words "or equal."

Contractor may, unless otherwise stated, offer for substitution any material, process or article which shall be substantially equal or better in every respect to that so indicated or specified in this Contract. However, the City may have adopted certain uniform standards for certain materials, processes and articles. Contractor shall submit requests, together with substantiating data, for substitution of any "or equal" material, process or article no later than five (5) days after award of the Contract. To facilitate the construction schedule and sequencing, some requests may need to be submitted before five (5) days after award of Contract. Provisions regarding submission of "or equal" requests shall not in any way authorize an extension of time for performance of this Contract. If a proposed "or equal" substitution request is rejected, Contractor shall be responsible for providing the specified material, process or article. The burden of proof as to the equality of any material, process or article shall rest with Contractor.

The City has the complete and sole discretion to determine if a material, process or article is an "or equal" material, process or article that may be substituted. Data required to substantiate requests for substitutions of an "or equal" material, process or article data shall include a signed affidavit from Contractor stating that, and describing how, the substituted "or equal" material, process or article is equivalent to that specified in every way except as listed on the affidavit. Substantiating data shall include any and all illustrations, specifications, and other relevant data including catalog information which describes the requested substituted "or equal" material, process or article, and substantiates that it is an "or equal" to the material, process or

article. The substantiating data must also include information regarding the durability and lifecycle cost of the requested substituted “or equal” material, process or article. Failure to submit all the required substantiating data, including the signed affidavit, to the City in a timely fashion will result in the rejection of the proposed substitution.

Contractor shall bear all of the City’s costs associated with the review of substitution requests. Contractor shall be responsible for all costs related to a substituted “or equal” material, process or article. Contractor is directed to the Special Conditions (if any) to review any findings made pursuant to Public Contract Code section 3400.

### 3.3 Period of Performance.

3.3.1 Contract Time. Contractor shall perform and complete all Work under this Contract within **5** days, beginning the effective date of the Notice to Proceed (“Contract Time”). Contractor shall perform its Work in strict accordance with any completion schedule, construction schedule or project milestones developed by the City. Such schedules or milestones may be included as part of Exhibits “A” or “B” attached hereto, or may be provided separately in writing to Contractor. Contractor agrees that if such Work is not completed within the aforementioned Contract Time and/or pursuant to any such completion schedule, construction schedule or project milestones developed pursuant to provisions of the Contract, it is understood, acknowledged and agreed that the City will suffer damage.

3.3.2 Force Majeure. Neither City nor Contractor shall be considered in default of this Contract for delays in performance caused by circumstances beyond the reasonable control of the non-performing party. For purposes of this Contract, such circumstances include but are not limited to, abnormal weather conditions; floods; earthquakes; fire; pandemics or epidemics; war; riots and other civil disturbances; strikes, lockouts, work slowdowns, and other labor disturbances; sabotage or judicial restraint. Should such circumstances occur, the non-performing party shall, within a reasonable time of being prevented from performing, give written notice to the other party describing the circumstances preventing continued performance and the efforts being made to resume performance of this Contract. Contractor’s exclusive remedy in the event of delay covered under this section shall be a non-compensable extension of the Contract Time.

3.3.3 Liquidated Damages. Pursuant to Government Code Section 53069.85, Contractor shall pay to the City as fixed and liquidated damages the sum of **One Thousand Two Hundred Dollars (\$1,200)** per day for each and every calendar day of delay beyond the Contract Time or beyond any completion schedule, construction schedule or Project milestones established pursuant to the Contract.

3.4 Standard of Performance; Performance of Employees. Contractor shall perform all Work under this Contract in a skillful and workmanlike manner, and consistent with the standards generally recognized as being employed by professionals in the same discipline in the State of California. Contractor represents and maintains that it is skilled in the professional calling necessary to perform the Work. Contractor warrants that all employees and subcontractors shall have sufficient skill and experience to perform the Work assigned to them. Finally, Contractor represents that it, its employees and subcontractors have all licenses, permits, qualifications and approvals of whatever nature that are legally required to perform the Work, including any required business license, and that such licenses and approvals shall be maintained throughout the term of this Contract. As provided for in the indemnification provisions of this Contract, Contractor shall perform, at its own cost and expense and without reimbursement from the City, any work

the standard of care provided for herein. Any employee who is determined by the City to be uncooperative, incompetent, a threat to the safety of persons or the Work, or any employee who fails or refuses to perform the Work in a manner acceptable to the City, shall be promptly removed from the Project by Contractor and shall not be reemployed on the Work.

3.5 Control and Payment of Subordinates; Contractual Relationship. City retains Contractor on an independent contractor basis and Contractor is not an employee of City. Any additional personnel performing the work governed by this Contract on behalf of Contractor shall at all times be under Contractor's exclusive direction and control. Contractor shall pay all wages, salaries, and other amounts due such personnel in connection with their performance under this Contract and as required by law. Contractor shall be responsible for all reports and obligations respecting such additional personnel, including, but not limited to: social security taxes, income tax withholding, unemployment insurance, and workers' compensation insurance.

3.6 City's Basic Obligation. City agrees to engage and does hereby engage Contractor as an independent contractor to furnish all materials and to perform all Work according to the terms and conditions herein contained for the sum set forth above. Except as otherwise provided in the Contract, the City shall pay to Contractor, as full consideration for the satisfactory performance by Contractor of the services and obligations required by this Contract, the below-referenced compensation in accordance with compensation provisions set forth in the Contract.

3.7 Compensation and Payment.

3.7.1 Amount of Compensation. As consideration for performance of the Work required herein, City agrees to pay Contractor the Total Contract Price of **one hundred four thousand one hundred twenty five dollars (\$104,125.00)** ("Total Contract Price") provided that such amount shall be subject to adjustment pursuant to the applicable terms of this Contract or written change orders approved and signed in advance by the City.

3.7.2 Payment of Compensation. If the Work is scheduled for completion in thirty (30) or less calendar days, City will arrange for payment of the Total Contract Price upon completion and approval by City of the Work. If the Work is scheduled for completion in more than thirty (30) calendar days, City will pay Contractor on a monthly basis as provided for herein. On or before the fifth (5th) day of each month, Contractor shall submit to the City an itemized application for payment in the format supplied by the City indicating the amount of Work completed since commencement of the Work or since the last progress payment. These applications shall be supported by evidence which is required by this Contract and such other documentation as the City may require. The Contractor shall certify that the Work for which payment is requested has been done and that the materials listed are stored where indicated. Contractor may be required to furnish a detailed schedule of values upon request of the City and in such detail and form as the City shall request, showing the quantities, unit prices, overhead, profit, and all other expenses involved in order to provide a basis for determining the amount of progress payments.

3.7.3 Prompt Payment. City shall review and pay all progress payment requests in accordance with the provisions set forth in Section 20104.50 of the California Public Contract Code. However, no progress payments will be made for Work not completed in accordance with this Contract. Contractor shall comply with all applicable laws, rules and regulations relating to the proper payment of its employees, subcontractors, suppliers or others.

3.7.4 Contract Retentions. From each approved progress estimate, five percent (5%) will be deducted and retained by the City, and the remainder will be paid to Contractor. All Contract retention shall be released and paid to Contractor and subcontractors pursuant to California Public Contract Code Section 7107.

3.7.5 Other Retentions. In addition to Contract retentions, the City may deduct from each progress payment an amount necessary to protect City from loss because of: (1) liquidated damages which have accrued as of the date of the application for payment; (2) any sums expended by the City in performing any of Contractor's obligations under the Contract which Contractor has failed to perform or has performed inadequately; (3) defective Work not remedied; (4) stop notices as allowed by state law; (5) reasonable doubt that the Work can be completed for the unpaid balance of the Total Contract Price or within the scheduled completion date; (6) unsatisfactory prosecution of the Work by Contractor; (7) unauthorized deviations from the Contract; (8) failure of Contractor to maintain or submit on a timely basis proper and sufficient documentation as required by the Contract or by City during the prosecution of the Work; (9) erroneous or false estimates by Contractor of the value of the Work performed; (10) any sums representing expenses, losses, or damages as determined by the City, incurred by the City for which Contractor is liable under the Contract; and (11) any other sums which the City is entitled to recover from Contractor under the terms of the Contract or pursuant to state law, including Section 1727 of the California Labor Code. The failure by the City to deduct any of these sums from a progress payment shall not constitute a waiver of the City's right to such sums.

3.7.6 Substitutions for Contract Retentions. In accordance with California Public Contract Code Section 22300, the City will permit the substitution of securities for any monies withheld by the City to ensure performance under the Contract. At the request and expense of Contractor, securities equivalent to the amount withheld shall be deposited with the City, or with a state or federally chartered bank in California as the escrow agent, and thereafter the City shall then pay such monies to Contractor as they come due. Upon satisfactory completion of the Contract, the securities shall be returned to Contractor. For purposes of this Section and Section 22300 of the Public Contract Code, the term "satisfactory completion of the contract" shall mean the time the City has issued written final acceptance of the Work and filed a Notice of Completion as required by law and provisions of this Contract. Contractor shall be the beneficial owner of any securities substituted for monies withheld and shall receive any interest thereon. The escrow agreement used for the purposes of this Section shall be in the form provided by the City.

3.7.7 Title to Work. As security for partial, progress, or other payments, title to Work for which such payments are made shall pass to the City at the time of payment. To the extent that title has not previously been vested in the City by reason of payments, full title shall pass to the City at delivery of the Work at the destination and time specified in this Contract. Such transferred title shall in each case be good, free and clear from any and all security interests, liens, or other encumbrances. Contractor promises and agrees that it will not pledge, hypothecate, or otherwise encumber the items in any manner that would result in any lien, security interest, charge, or claim upon or against said items. Such transfer of title shall not imply acceptance by the City, nor relieve Contractor from the responsibility to strictly comply with the Contract, and shall not relieve Contractor of responsibility for any loss of or damage to items.

3.7.8 Labor and Material Releases. Contractor shall furnish City with labor and material releases from all subcontractors performing work on, or furnishing materials for, the Work governed by this Contract prior to final payment by City.

3.7.9 Prevailing Wages. Contractor is aware of the requirements of California Labor Code Section 1720 et seq., and 1770 et seq., as well as California Code of Regulations, Title 8, Section 16000 et seq., (“Prevailing Wage Laws”), which require the payment of prevailing wage rates and the performance of other requirements on “public works” and “maintenance” projects. Since the Services are being performed as part of an applicable “public works” or “maintenance” project, as defined by the Prevailing Wage Laws, and since the total compensation is \$1,000 or more, Contractor agrees to fully comply with such Prevailing Wage Laws. City shall provide Contractor with a copy of the prevailing rates of per diem wages in effect at the commencement of this Contract upon request. Contractor shall make copies of the prevailing rates of per diem wages for each craft, classification or type of worker needed to execute the Services available to interested parties upon request, and shall post copies at Contractor’s principal place of business and at the project site. Contractor shall defend, indemnify and hold the City, its officials, officers, employees and agents free and harmless from any claim or liability arising out of any failure or alleged failure to comply with the Prevailing Wage Laws. Contractor and any subcontractor shall forfeit a penalty of up to \$200 per calendar day or portion thereof for each worker paid less than the prevailing wage rates.

3.7.10 Apprenticeable Crafts. When Contractor employs workmen in an apprenticeable craft or trade, Contractor shall comply with the provisions of Section 1777.5 of the California Labor Code with respect to the employment of properly registered apprentices upon public works. The primary responsibility for compliance with said section for all apprenticeable occupations shall be with Contractor. The Contractor or any subcontractor that is determined by the Labor Commissioner to have knowingly violated Section 1777.5 shall forfeit as a civil penalty an amount not exceeding \$100 for each full calendar day of noncompliance, or such greater amount as provided by law.

3.7.11 Hours of Work. Contractor is advised that eight (8) hours labor constitutes a legal day’s work. Pursuant to Section 1813 of the California Labor Code, Contractor shall forfeit a penalty of \$25.00 per worker for each day that each worker is permitted to work more than eight (8) hours in any one calendar day and forty (40) hours in any one calendar week, except when payment for overtime is made at not less than one and onehalf (1 1/2) times the basic rate for that worker.

3.7.12 Payroll Records. Contractor and each subcontractor shall keep an accurate payroll record, showing the name, address, social security number, work classification, straight time and overtime hours worked each day and week, and the actual per diem wages paid to each journeyman, apprentice, worker, or other employee employed by him or her in connection with the public work. The payroll records shall be certified and shall be available for inspection at all reasonable hours at the principal office of Contractor in the manner provided in Labor Code section 1776. In the event of noncompliance with the requirements of this section, Contractor shall have 10 days in which to comply subsequent to receipt of written notice specifying in what respects such Contractor must comply with this section. Should noncompliance still be evident after such 10-day period, Contractor shall, as a penalty to City, forfeit not more than \$100.00 for each calendar day or portion thereof, for each worker, until strict compliance is effectuated. The amount of the forfeiture is to be determined by the Labor Commissioner. A contractor who is found to have violated the provisions of law regarding wages on Public Works with the intent to defraud shall be ineligible to bid on Public Works contracts for a period of one to three years as determined by the Labor Commissioner. Upon the request of the Division of Apprenticeship Standards or the Division of Labor Standards Enforcement, such penalties shall be withheld from progress payments then due. The responsibility for compliance with this section is on Contractor. The requirement to submit certified payroll records directly to the Labor Commissioner under

Labor Code section 1771.4 shall not apply to work performed on a public works project that is exempt pursuant to the small project exemption specified in Labor Code Section 1771.4.

3.7.13 Contractor and Subcontractor Registration. Pursuant to Labor Code sections 1725.5 and 1771.1, all contractors and subcontractors that wish to bid on, be listed in a bid proposal, or enter into a contract to perform public work must be registered with the Department of Industrial Relations. No bid will be accepted nor any contract entered into without proof of the contractor's and subcontractors' current registration with the Department of Industrial Relations to perform public work. Contractor is directed to review, fill out and execute the Public Works Contractor Registration Certification attached hereto as Exhibit "E" prior to contract execution. Notwithstanding the foregoing, the contractor registration requirements mandated by Labor Code Sections 1725.5 and 1771.1 shall not apply to work performed on a public works project that is exempt pursuant to the small project exemption specified in Labor Code Sections 1725.5 and 1771.1.

3.7.14 Labor Compliance; Stop Orders. This Project is subject to compliance monitoring and enforcement by the Department of Industrial Relations. It shall be the Contractor's sole responsibility to evaluate and pay the cost of complying with all labor compliance requirements under this Contract and applicable law. Any stop orders issued by the Department of Industrial Relations against Contractor or any subcontractor that affect Contractor's performance of Work, including any delay, shall be Contractor's sole responsibility. Any delay arising out of or resulting from such stop orders shall be considered Contractor caused delay subject to any applicable liquidated damages and shall not be compensable by the City. Contractor shall defend, indemnify and hold the City, its officials, officers, employees and agents free and harmless from any claim or liability arising out of stop orders issued by the Department of Industrial Relations against Contractor or any subcontractor.

### 3.8 Performance of Work; Jobsite Obligations.

#### 3.8.1 Water Quality Management and Compliance.

3.8.1.1 Water Quality Management and Compliance. Contractor shall keep itself and all subcontractors, staff, and employees fully informed of and in compliance with all local, state and federal laws, rules and regulations that may impact, or be implicated by the performance of the Work including, without limitation, all applicable provisions of the Federal Water Pollution Control Act (33 U.S.C. §§ 1300); the California Porter-Cologne Water Quality Control Act (Cal Water Code §§ 13000-14950); local ordinances regulating discharges of storm water; and any and all regulations, policies, or permits issued pursuant to any such authority regulating the discharge of pollutants, as that term is used in the Porter-Cologne Water Quality Control Act, to any ground or surface water in the State.

3.8.1.2 Compliance with the Statewide Construction General Permit. Contractor shall comply with all conditions of the most recent iteration of the National Pollutant Discharge Elimination System General Permit for Storm Water Discharges Associated with Construction Activity, issued by the California State Water Resources Control Board ("Permit"). It shall be Contractor's sole responsibility to file a Notice of Intent and procure coverage under the Permit for all construction activity which results in the disturbance of more than one acre of total land area or which is part of a larger common area of development or sale. Prior to initiating work, Contractor shall be solely responsible for preparing and implementing a Storm Water Pollution Prevention Plan (SWPPP) as required by the Permit. Contractor shall be responsible for procuring, implementing and complying with the provisions of the Permit and the

SWPPP, including the standard provisions, and monitoring and reporting requirements as required by the Permit. The Permit requires the SWPPP to be a “living document” that changes as necessary to meet the conditions and requirements of the job site as it progresses through different phases of construction and is subject to different weather conditions. It shall be Contractor’s sole responsibility to update the SWPPP as necessary to address conditions at the project site.

3.8.1.3 Other Water Quality Rules Regulations and Policies. Contractor shall comply with the lawful requirements of any applicable municipality, drainage City, or local agency regarding discharges of storm water to separate storm drain systems or other watercourses under their jurisdiction, including applicable requirements in municipal storm water management programs.

3.8.1.4 Cost of Compliance. Storm, surface, nuisance, or other waters may be encountered at various times during construction of The Work. Therefore, the Contractor, by submitting a Bid, hereby acknowledges that it has investigated the risk arising from such waters, has prepared its Bid accordingly, and assumes any and all risks and liabilities arising therefrom.

3.8.1.5 Liability for Non-Compliance. Failure to comply with the Permit is a violation of federal and state law. Pursuant to the indemnification provisions of this Contract, Contractor hereby agrees to defend, indemnify and hold harmless the City and its officials, officers, employees, volunteers and agents for any alleged violations. In addition, City may seek damages from Contractor for any delay in completing the Work in accordance with the Contract, if such delay is caused by or related to Contractor’s failure to comply with the Permit.

3.8.1.6 Reservation of Right to Defend. City reserves the right to defend any enforcement action brought against the City for Contractor’s failure to comply with the Permit or any other relevant water quality law, regulation, or policy. Pursuant to the indemnification provisions of this Contract, Contractor hereby agrees to be bound by, and to reimburse the City for the costs (including the City’s attorney’s fees) associated with, any settlement reached between the City and the relevant enforcement entity.

3.8.1.7 Training. In addition to the standard of performance requirements set forth in paragraph 3.4, Contractor warrants that all employees and subcontractors shall have sufficient skill and experience to perform the Work assigned to them without impacting water quality in violation of the laws, regulations and policies described in paragraph 3.8.1. Contractor further warrants that it, its employees and subcontractors will receive adequate training, as determined by City, regarding the requirements of the laws, regulations and policies described in paragraph 3.8.1 as they may relate to the Work provided under this Contract. Upon request, City will provide the Contractor with a list of training programs that meet the requirements of this paragraph.

3.8.2 Safety. Contractor shall execute and maintain its work so as to avoid injury or damage to any person or property. Contractor shall comply with the requirements of the specifications relating to safety measures applicable in particular operations or kinds of work. In carrying out its Work, Contractor shall at all times be in compliance with all applicable local, state and federal laws, rules and regulations, and shall exercise all necessary precautions for the safety of employees appropriate to the nature of the Work and the conditions under which the Work is to be performed. Safety precautions as applicable shall include, but shall not be limited to, adequate life protection and lifesaving equipment; adequate illumination for underground and

night operations; instructions in accident prevention for all employees, such as machinery guards, safe walkways, scaffolds, ladders, bridges, gang planks, confined space procedures, trenching and shoring, fall protection and other safety devices, equipment and wearing apparel as are necessary or lawfully required to prevent accidents or injuries; and adequate facilities for the proper inspection and maintenance of all safety measures. Furthermore, Contractor shall prominently display the names and telephone numbers of at least two medical doctors practicing in the vicinity of the Project, as well as the telephone number of the local ambulance service, adjacent to all telephones at the Project site.

3.8.3 Laws and Regulations. Contractor shall keep itself fully informed of and in compliance with all local, state and federal laws, rules and regulations in any manner affecting the performance of the Contract or the Work, including all Cal/OSHA requirements, and shall give all notices required by law. Contractor shall be liable for all violations of such laws and regulations in connection with Work. If Contractor observes that the drawings or specifications are at variance with any law, rule or regulation, it shall promptly notify the City in writing. Any necessary changes shall be made by written change order. If Contractor performs any work knowing it to be contrary to such laws, rules and regulations and without giving written notice to the City, Contractor shall be solely responsible for all costs arising therefrom. City is a public entity of the State of California subject to certain provisions of the Health & Safety Code, Government Code, Public Contract Code, and Labor Code of the State. It is stipulated and agreed that all provisions of the law applicable to the public contracts of a municipality are a part of this Contract to the same extent as though set forth herein and will be complied with. Contractor shall defend, indemnify and hold City, its officials, officers, employees and agents free and harmless, pursuant to the indemnification provisions of this Contract, from any claim or liability arising out of any failure or alleged failure to comply with such laws, rules or regulations.

3.8.4 Permits and Licenses. Contractor shall be responsible for securing City permits and licenses necessary to perform the Work described herein, including, but not limited to, any required business license. While Contractor will not be charged a fee for any City permits, Contractor shall pay the City's business license fee, if any. Any ineligible contractor or subcontractor pursuant to Labor Code Sections 1777.1 and 1777.7 may not perform work on this Project.

3.8.5 Trenching Work. If the Total Contract Price exceeds \$25,000 and if the Work governed by this Contract entails excavation of any trench or trenches five (5) feet or more in depth, Contractor shall comply with all applicable provisions of the California Labor Code, including Section 6705. To this end, Contractor shall submit for City's review and approval a detailed plan showing the design of shoring, bracing, sloping, or other provisions to be made for worker protection from the hazard of caving ground during the excavation of such trench or trenches. If such plan varies from the shoring system standards, the plan shall be prepared by a registered civil or structural engineer.

3.8.6 Hazardous Materials and Differing Conditions. As required by California Public Contract Code Section 7104, if this Contract involves digging trenches or other excavations that extend deeper than four (4) feet below the surface, Contractor shall promptly, and prior to disturbance of any conditions, notify City of: (1) any material discovered in excavation that Contractor believes to be a hazardous waste that is required to be removed to a Class I, Class II or Class III disposal site; (2) subsurface or latent physical conditions at the site differing from those indicated by City; and (3) unknown physical conditions of an unusual nature at the site, significantly different from those ordinarily encountered in such contract work. Upon notification, City shall promptly investigate the conditions to determine whether a change order is appropriate.

In the event of a dispute, Contractor shall not be excused from any scheduled completion date and shall proceed with all Work to be performed under the Contract, but shall retain all rights provided by the Contract or by law for making protests and resolving the dispute.

3.8.7 Underground Utility Facilities. To the extent required by Section 4215 of the California Government Code, City shall compensate Contractor for the costs of: (1) locating and repairing damage to underground utility facilities not caused by the failure of Contractor to exercise reasonable care; (2) removing or relocating underground utility facilities not indicated in the construction drawings; and (3) equipment necessarily idled during such work. Contractor shall not be assessed liquidated damages for delay caused by failure of City to provide for removal or relocation of such utility facilities.

3.8.8 Air Quality. Contractor shall fully comply, and shall ensure all subcontractors comply, with all applicable laws, rules and regulations in furnishing or using equipment and/or providing services, including, but not limited to, emissions limits and permitting requirements imposed by the California Air Resources Board (CARB) and all applicable terms of Title 13, California Code of Regulations Division 3, Chapter 9 ("Regulation"). Although CARB limits and requirements are more broad, Contractor shall specifically be aware of their application to "portable equipment", which definition is considered by CARB to include any item of equipment with a fuel-powered engine. Contractor shall indemnify City against any fines or penalties imposed by CARB, or any other governmental or regulatory agency for violations of applicable laws, rules and/or regulations by Contractor, its subcontractors, or others for whom Contractor is responsible under its indemnity obligations provided for in this Contract.

Throughout the Project, and for three (3) years thereafter, Contractor shall make available for inspection and copying any and all documents or information associated with Contractor's and its subcontractors' fleets including, without limitation, the Certificates of Reported Compliance ("CRCs"), fuel/refueling records, maintenance records, emissions records, and any other information the Contractor is required to produce, keep or maintain pursuant to the Regulation upon two (2) calendar days' notice from the City.

Contractor shall be solely liable for any and all costs associated with compliance with the Regulation as well as for any and all penalties, fines, damages, or costs associated with any and all violations, or failures to comply with the Regulation. Contractor shall defend, indemnify and hold harmless the City, its officials, officers, employees and authorized volunteers free and harmless from any claims, liabilities, costs, penalties or interest arising out of any failure or alleged failure to comply with the Regulation.

3.8.9 State Recycling Mandates. Contractor shall comply with State Recycling Mandates. Any recyclable materials/debris collected by the contractor that can be feasibly diverted via reuse or recycling must be hauled by the appropriate handler for reuse or recycling.

3.9 Completion of Work. When Contractor determines that it has completed the Work required herein, Contractor shall so notify City in writing and shall furnish all labor and material releases required by this Contract. City shall thereupon inspect the Work. If the Work is not acceptable to the City, the City shall indicate to Contractor in writing the specific portions or items of Work which are unsatisfactory or incomplete. Once Contractor determines that it has completed the incomplete or unsatisfactory Work, Contractor may request a reinspection by the City. Once the Work is acceptable to City, City shall pay to Contractor the Total Contract Price remaining to be paid, less any amount which City may be authorized or directed by law to retain.

Payment of retention proceeds due to Contractor shall be made in accordance with Section 7107 of the California Public Contract Code.

3.10 Claims; Government Code Claim Compliance.

3.10.1 Intent. Effective January 1, 1991, Section 20104 et seq., of the California Public Contract Code prescribes a process utilizing informal conferences, non-binding judicial supervised mediation, and judicial arbitration to resolve disputes on construction claims of \$375,000 or less. Effective January 1, 2017, Section 9204 of the Public Contract Code prescribes a process for negotiation and mediation to resolve disputes on construction claims. The intent of this Section is to implement Sections 20104 et seq. and Section 9204 of the California Public Contract Code. This Section shall be construed to be consistent with said statutes.

3.10.2 Claims. For purposes of this Section, "Claim" means a separate demand by the Contractor, after a change order duly requested in accordance with the terms of this Contract has been denied by the City, for (A) a time extension, (B) payment of money or damages arising from Work done by or on behalf of the Contractor pursuant to the Contract, or (C) an amount the payment of which is disputed by the City. A "Claim" does not include any demand for payment for which the Contractor has failed to provide notice, request a change order, or otherwise failed to follow any procedures contained in the Contract Documents. Claims governed by this Section may not be filed unless and until the Contractor completes all procedures for giving notice of delay or change and for the requesting of a time extension or change order, including but not necessarily limited to the change order procedures contained herein, and Contractor's request for a change has been denied in whole or in part. Claims governed by this Section must be filed no later than fourteen (14) days after a request for change has been denied in whole or in part or after any other event giving rise to the Claim. The Claim shall be submitted in writing to the City and shall include on its first page the following in 16 point capital font: "THIS IS A CLAIM." Furthermore, the claim shall include the documents necessary to substantiate the claim. Nothing in this Section is intended to extend the time limit or supersede notice requirements otherwise provided by contract for the filing of claims, including all requirements pertaining to compensation or payment for extra Work, disputed Work, and/or changed conditions. Failure to follow such contractual requirements shall bar any claims or subsequent lawsuits for compensation or payment thereon.

3.10.3 Supporting Documentation. The Contractor shall submit all claims in the following format:

3.10.3.1 Summary of claim merit and price, reference Contract Document provisions pursuant to which the claim is made

3.10.3.2 List of documents relating to claim:

- (A) Specifications
- (B) Drawings
- (C) Clarifications (Requests for Information)
- (D) Schedules
- (E) Other

3.10.3.3 Chronology of events and correspondence

3.10.3.4 Analysis of claim merit

3.10.3.5 Analysis of claim cost

3.10.3.6 Time impact analysis in CPM format

3.10.3.7 If Contractor's claim is based in whole or in part on an allegation of errors or omissions in the Drawings or Specifications for the Project, Contractor shall provide a summary of the percentage of the claim subject to design errors or omissions and shall obtain a certificate of merit in support of the claim of design errors and omissions.

3.10.3.8 Cover letter and certification of validity of the claim, including any claims from subcontractors of any tier, in accordance with Government Code section 12650 *et seq.*

3.10.4 City's Response. Upon receipt of a claim pursuant to this Section, City shall conduct a reasonable review of the claim and, within a period not to exceed 45 days, shall provide the Contractor a written statement identifying what portion of the claim is disputed and what portion is undisputed. Any payment due on an undisputed portion of the claim will be processed and made within 60 days after the public entity issues its written statement.

3.10.4.1 If City needs approval from its governing body to provide the Contractor a written statement identifying the disputed portion and the undisputed portion of the claim, and the governing body does not meet within the 45 days or within the mutually agreed to extension of time following receipt of a claim sent by registered mail or certified mail, return receipt requested, City shall have up to three days following the next duly publicly noticed meeting of the governing body after the 45-day period, or extension, expires to provide the Contractor a written statement identifying the disputed portion and the undisputed portion.

3.10.4.2 Within 30 days of receipt of a claim, City may request in writing additional documentation supporting the claim or relating to defenses or claims City may have against the Contractor. If additional information is thereafter required, it shall be requested and provided pursuant to this subdivision, upon mutual agreement of City and the Contractor.

3.10.4.3 City's written response to the claim, as further documented, shall be submitted to the Contractor within 30 days (if the claim is less than \$50,000, within 15 days) after receipt of the further documentation, or within a period of time no greater than that taken by the Contractor in producing the additional information or requested documentation, whichever is greater.

3.10.5 Meet and Confer. If the Contractor disputes City's written response, or City fails to respond within the time prescribed, the Contractor may so notify City, in writing, either within 15 days of receipt of City's response or within 15 days of City's failure to respond within the time prescribed, respectively, and demand an informal conference to meet and confer for settlement of the issues in dispute. Upon receipt of a demand, City shall schedule a meet and confer conference within 30 days for settlement of the dispute.

3.10.6 Mediation. Within 10 business days following the conclusion of the meet and confer conference, if the claim or any portion of the claim remains in dispute, City shall provide the Contractor a written statement identifying the portion of the claim that remains in dispute and

the portion that is undisputed. Any payment due on an undisputed portion of the claim shall be processed and made within 60 days after City issues its written statement. Any disputed portion of the claim, as identified by the Contractor in writing, shall be submitted to nonbinding mediation, with City and the Contractor sharing the associated costs equally. City and Contractor shall mutually agree to a mediator within 10 business days after the disputed portion of the claim has been identified in writing, unless the parties agree to select a mediator at a later time.

3.10.6.1 If the Parties cannot agree upon a mediator, each Party shall select a mediator and those mediators shall select a qualified neutral third party to mediate with regard to the disputed portion of the claim. Each Party shall bear the fees and costs charged by its respective mediator in connection with the selection of the neutral mediator.

3.10.6.2 For purposes of this section, mediation includes any nonbinding process, including, but not limited to, neutral evaluation or a dispute review board, in which an independent third party or board assists the Parties in dispute resolution through negotiation or by issuance of an evaluation. Any mediation utilized shall conform to the timeframes in this section.

3.10.6.3 Unless otherwise agreed to by City and the Contractor in writing, the mediation conducted pursuant to this section shall excuse any further obligation under Section 20104.4 to mediate after litigation has been commenced.

3.10.6.4 The mediation shall be held no earlier than the date the Contractor completes the Work or the date that the Contractor last performs Work, whichever is earlier. All unresolved claims shall be considered jointly in a single mediation, unless a new unrelated claim arises after mediation is completed.

3.10.7 Procedures After Mediation. If following the mediation, the claim or any portion remains in dispute, the Contractor must file a claim pursuant to Chapter 1 (commencing with Section 900) and Chapter 2 (commencing with Section 910) of Part 3 of Division 3.6 of Title 1 of the Government Code. For purposes of those provisions, the running of the period of time within which a claim must be filed shall be tolled from the time the Contractor submits his or her written claim pursuant to subdivision (a) until the time the claim is denied, including any period of time utilized by the meet and confer conference or mediation.

3.10.8 Civil Actions. The following procedures are established for all civil actions filed to resolve claims subject to this Section:

3.10.8.1 Within 60 days, but no earlier than 30 days, following the filing or responsive pleadings, the court shall submit the matter to non-binding mediation unless waived by mutual stipulation of both parties or unless mediation was held prior to commencement of the action in accordance with Public Contract Code section 9204 and the terms of these procedures.. The mediation process shall provide for the selection within 15 days by both parties of a disinterested third person as mediator, shall be commenced within 30 days of the submittal, and shall be concluded within 15 days from the commencement of the mediation unless a time requirement is extended upon a good cause showing to the court.

3.10.8.2 If the matter remains in dispute, the case shall be submitted to judicial arbitration pursuant to Chapter 2.5 (commencing with Section 1141.10) of Title 3 of Part 3 of the Code of Civil Procedure, notwithstanding Section 1114.11 of that code. The Civil Discovery Act of 1986 (Article 3 (commencing with Section 2016) of Chapter 3 of Title 3 of Part 4

of the Code of Civil Procedure) shall apply to any proceeding brought under this subdivision consistent with the rules pertaining to judicial arbitration.

3.10.8.3 In addition to Chapter 2.5 (commencing with Section 1141.10) of Title 3 of Part 3 of the Code of Civil Procedure, (A) arbitrators shall, when possible, be experienced in construction law, and (B) any party appealing an arbitration award who does not obtain a more favorable judgment shall, in addition to payment of costs and fees under that chapter, also pay the attorney's fees on appeal of the other party.

3.10.9 Government Code Claims. In addition to any and all contract requirements pertaining to notices of and requests for compensation or payment for extra work, disputed work, claims and/or changed conditions, Contractor must comply with the claim procedures set forth in Government Code sections 900 et seq. prior to filing any lawsuit against the City. Such Government Code claims and any subsequent lawsuit based upon the Government Code claims shall be limited to those matters that remain unresolved after all procedures pertaining to extra work, disputed work, claims, and/or changed conditions have been followed by Contractor. If no such Government Code claim is submitted, or if any prerequisite contractual requirements are not otherwise satisfied as specified herein, Contractor shall be barred from bringing and maintaining a valid lawsuit against the City. A Government Code claim must be filed no earlier than the date the work is completed or the date the Contractor last performs work on the Project, whichever occurs first. A Government Code claim shall be inclusive of all unresolved claims unless a new unrelated claim arises after the Government Code claim is submitted.

3.10.10 Non-Waiver. City's failure to respond to a claim from the Contractor within the time periods described in this Section or to otherwise meet the time requirements of this Section shall result in the claim being deemed rejected in its entirety. City's failure to respond shall not waive City's rights to any subsequent procedures for the resolution of disputed claims.

3.11 Loss and Damage. Except as may otherwise be limited by law, Contractor shall be responsible for all loss and damage which may arise out of the nature of the Work agreed to herein, or from the action of the elements, or from any unforeseen difficulties which may arise or be encountered in the prosecution of the Work until the same is fully completed and accepted by City. In the event of damage proximately caused by an Act of God, as defined by Section 7105 of the Public Contract Code, the City may terminate this Contract pursuant to Section 3.17.3; provided, however, that the City needs to provide Contractor with only one (1) day advanced written notice.

### 3.12 Indemnification.

3.12.1 Scope of Indemnity. To the fullest extent permitted by law, Contractor shall defend, indemnify and hold the City, its officials, employees, agents and authorized volunteers free and harmless from any and all claims, demands, causes of action, suits, actions, proceedings, costs, expenses, liability, judgments, awards, decrees, settlements, loss, damage or injury of any kind, in law or equity, to property or persons, including wrongful death, (collectively, "Claims") in any manner arising out of, pertaining to, or incident to any alleged acts, errors or omissions, or willful misconduct of Contractor, its officials, officers, employees, subcontractors, consultants or agents in connection with the performance of the Contractor's services, the Project or this Contract, including without limitation the payment of all consequential damages, expert witness fees and attorneys' fees and other related costs and expenses. Notwithstanding the foregoing, to the extent required by Civil Code section 2782, Contractor's indemnity obligation shall not apply to liability for damages for death or bodily injury to persons,

injury to property, or any other loss, damage or expense arising from the sole or active negligence or willful misconduct of the City or the City's agents, servants, or independent contractors who are directly responsible to the City, or for defects in design furnished by those persons.

3.12.2 Additional Indemnity Obligations. Contractor shall defend, with counsel of City's choosing and at Contractor's own cost, expense and risk, any and all Claims covered by this section that may be brought or instituted against City or its officials, employees, agents and authorized volunteers. In addition, Contractor shall pay and satisfy any judgment, award or decree that may be rendered against City or its officials, employees, agents and authorized volunteers as part of any such claim, suit, action or other proceeding. Contractor shall also reimburse City for the cost of any settlement paid by City or its officials, employees, agents and authorized volunteers as part of any such claim, suit, action or other proceeding. Such reimbursement shall include payment for City's attorney's fees and costs, including expert witness fees. Contractor shall reimburse City and its officials, employees, agents and authorized volunteers, for any and all legal expenses and costs incurred by each of them in connection therewith or in enforcing the indemnity herein provided. Contractor's obligation to indemnify shall not be restricted to insurance proceeds, if any, received by the City, its officials, employees, agents and authorized volunteers.

### 3.13 Insurance.

3.13.1 Time for Compliance. Contractor shall not commence Work under this Contract until it has provided evidence satisfactory to the City that it has secured all insurance required under this section. In addition, Contractor shall not allow any subcontractor to commence work on any subcontract until it has provided evidence satisfactory to the City that the subcontractor has secured all insurance required under this section. Failure to provide and maintain all required insurance shall be grounds for the City to terminate this Contract for cause.

3.13.2 Minimum Requirements. Contractor shall, at its expense, procure and maintain for the duration of the Contract insurance against claims for injuries to persons or damages to property which may arise from or in connection with the performance of the Work hereunder by Contractor, its agents, representatives, employees or subcontractors. Contractor shall also require all of its subcontractors to procure and maintain the same insurance for the duration of the Contract. Such insurance shall meet at least the following minimum levels of coverage:

3.13.2.1 Minimum Scope of Insurance. Coverage shall be at least as broad as the latest version of the following: (1) *General Liability*: Insurance Services Office Commercial General Liability coverage (occurrence form CG 00 01) OR Insurance Services Office Owners and Contractors Protective Liability Coverage Form (CG 00 09 11 88) (coverage for operations of designated contractor); (2) *Automobile Liability*: Insurance Services Office Business Auto Coverage form number CA 00 01, code 1 (any auto); and (3) *Workers' Compensation and Employer's Liability*: Workers' Compensation insurance as required by the State of California and Employer's Liability Insurance. Policies shall not contain exclusions contrary to this Contract.

3.13.2.2 Minimum Limits of Insurance. Contractor shall maintain limits no less than: (1) *General Liability*: \$2,000,000 per occurrence and \$4,000,000 aggregate for bodily injury, personal injury and property damage; (2) *Automobile Liability*: \$1,000,000 per accident for bodily injury and property damage; and (3) *Workers' Compensation and Employer's Liability*: Workers' compensation limits as required by the Labor Code of the State of California. Employer's Liability limits of \$1,000,000 each accident, policy limit bodily injury or disease, and

each employee bodily injury or disease. Defense costs shall be available in addition to the limits. Notwithstanding the minimum limits specified herein, any available coverage shall be provided to the parties required to be named as additional insureds pursuant to this Contract.

3.13.3 Insurance Endorsements. The insurance policies shall contain the following provisions, or Contractor shall provide endorsements (amendments) on forms supplied or approved by the City to add the following provisions to the insurance policies:

3.13.3.1 General Liability. (1) Such policy shall give the City, its officials, employees, agents and authorized volunteers additional insured status using ISO endorsements CG20 10 10 01 plus CG20 37 10 01, or endorsements providing the exact same coverage, with respect to the Work or operations performed by or on behalf of Contractor, including materials, parts or equipment furnished in connection with such work; (2) all policies shall waive or shall permit Contractor to waive all rights of subrogation which may be obtained by the Contractor or any insurer by virtue of payment of any loss or any coverage provided to any person named as an additional insured pursuant to this Contract, and Contractor agrees to waive all such rights of subrogation; and (3) the insurance coverage shall be primary insurance as respects the City, its officials, employees, agents and authorized volunteers, or if excess, shall stand in an unbroken chain of coverage excess of Contractor's scheduled underlying coverage. Any insurance or self-insurance maintained by the City, its officials, employees, agents and authorized volunteers shall be excess of Contractor's insurance and shall not be called upon to contribute with it.

3.13.3.2 Automobile Liability. (1) Such policy shall give the City, its officials, employees, agents and authorized volunteers additional insured status with respect to the ownership, operation, maintenance, use, loading or unloading of any auto owned, leased, hired or borrowed by Contractor or for which Contractor is responsible; (2) all policies shall waive or shall permit Contractor to waive all rights of subrogation which may be obtained by the Contractor or any insurer by virtue of payment of any loss or any coverage provided to any person named as an additional insured pursuant to this Contract, and Contractor agrees to waive all such rights of subrogation; and (3) the insurance coverage shall be primary insurance as respects the City, its officials, employees, agents and authorized volunteers, or if excess, shall stand in an unbroken chain of coverage excess of Contractor's scheduled underlying coverage. Any insurance or self-insurance maintained by the City, its officials, employees, agents and authorized volunteers shall be excess of Contractor's insurance and shall not be called upon to contribute with it in any way.

3.13.3.3 Workers' Compensation and Employer's Liability Coverage. The insurer shall agree to waive all rights of subrogation against the City, its officials, employees, agents and authorized volunteers for losses paid under the terms of the insurance policy which arise from work performed by Contractor.

3.13.3.4 All Coverages. Each insurance policy required by this Contract shall be endorsed to state that: (1) coverage shall not be suspended, voided, reduced or canceled except after thirty (30) days prior written notice by certified mail, return receipt requested, has been given to the City; and (2) any failure to comply with reporting or other provisions of the policies, including breaches of warranties, shall not affect coverage provided to the City, its officials, employees, agents and authorized volunteers.

3.13.4 Separation of Insureds; No Special Limitations. All insurance required by this Section shall contain standard separation of insureds provisions. In addition,

such insurance shall not contain any special limitations on the scope of protection afforded to the City, its officials, employees, agents and authorized volunteers.

3.13.5 Deductibles and Self-Insurance Retentions. Any deductibles or self-insured retentions must be declared to and approved by the City. Contractor shall guarantee that, at the option of the City, either: (1) the insurer shall reduce or eliminate such deductibles or self-insured retentions as respects the City, its officials, employees, agents and authorized volunteers; or (2) the Contractor shall procure a bond or other financial guarantee acceptable to the City guaranteeing payment of losses and related investigation costs, claims and administrative and defense expenses.

3.13.6 Acceptability of Insurers. Insurance is to be placed with insurers with a current A.M. Best's rating no less than A-:VII, licensed to do business in California, and satisfactory to the City. Exception may be made for the State Compensation Insurance Fund when not specifically rated.

3.13.7 Verification of Coverage. Contractor shall furnish City with original certificates of insurance and endorsements effecting coverage required by this Contract on forms satisfactory to the City. The certificates and endorsements for each insurance policy shall be signed by a person authorized by that insurer to bind coverage on its behalf, and shall be on forms supplied or approved by the City. All certificates and endorsements must be received and approved by the City before work commences. The City reserves the right to require complete, certified copies of all required insurance policies, at any time.

3.13.8 Subcontractors. All subcontractors shall meet the requirements of this Section before commencing Work. Contractor shall furnish separate certificates and endorsements for each subcontractor. Subcontractor policies of General Liability insurance shall name the City, its officials, employees, agents and authorized volunteers as additional insureds using form ISO 20 38 04 13 or endorsements providing the exact same coverage. All coverages for subcontractors shall be subject to all of the requirements stated herein except as otherwise agreed to by the City in writing.

3.13.9 Reporting of Claims. Contractor shall report to the City, in addition to Contractor's insurer, any and all insurance claims submitted by Contractor in connection with the Work under this Contract.

### 3.14 Bond Requirements.

3.14.1 Payment Bond. If required by law or otherwise specifically requested by City in Exhibit "C" attached hereto and incorporated herein by reference, Contractor shall execute and provide to City concurrently with this Contract a Payment Bond in an amount required by the City and in a form provided or approved by the City. If such bond is required, no payment will be made to Contractor until the bond has been received and approved by the City.

3.14.2 Performance Bond. If specifically requested by City in Exhibit "C" attached hereto and incorporated herein by reference, Contractor shall execute and provide to City concurrently with this Contract a Performance Bond in an amount required by the City and in a form provided or approved by the City. If such bond is required, no payment will be made to Contractor until the bond has been received and approved by the City.

3.14.3 Bond Provisions. Should, in City's sole opinion, any bond become insufficient or any surety be found to be unsatisfactory, Contractor shall renew or replace the

effected bond within (ten) 10 days of receiving notice from City. In the event the surety or Contractor intends to reduce or cancel any required bond, at least thirty (30) days prior written notice shall be given to the City, and Contractor shall post acceptable replacement bonds at least ten (10) days prior to expiration of the original bonds. No further payments shall be deemed due or will be made under this Contract until any replacement bonds required by this Section are accepted by the City. To the extent, if any, that the Total Contract Price is increased in accordance with the Contract, Contractor shall, upon request of the City, cause the amount of the bond to be increased accordingly and shall promptly deliver satisfactory evidence of such increase to the City. If Contractor fails to furnish any required bond, the City may terminate the Contract for cause.

3.14.4 Surety Qualifications. Only bonds executed by an admitted surety insurer, as defined in California Code of Civil Procedure Section 995.120, shall be accepted. If a California-admitted surety insurer issuing bonds does not meet these requirements, the insurer will be considered qualified if it is in conformance with Section 995.660 of the California Code of Civil Procedure, and proof of such is provided to the City.

3.15 Warranty. Contractor warrants all Work under the Contract (which for purposes of this Section shall be deemed to include unauthorized work which has not been removed and any nonconforming materials incorporated into the Work) to be of good quality and free from any defective or faulty material and workmanship. Contractor agrees that for a period of one year (or the period of time specified elsewhere in the Contract or in any guarantee or warranty provided by any manufacturer or supplier of equipment or materials incorporated into the Work, whichever is later) after the date of final acceptance, Contractor shall within ten (10) days after being notified in writing by the City of any defect in the Work or nonconformance of the Work to the Contract, commence and prosecute with due diligence all Work necessary to fulfill the terms of the warranty at its sole cost and expense. Contractor shall act sooner as requested by the City in response to an emergency. In addition, Contractor shall, at its sole cost and expense, repair and replace any portions of the Work (or work of other contractors) damaged by its defective Work or which becomes damaged in the course of repairing or replacing defective Work. For any Work so corrected, Contractor's obligation hereunder to correct defective Work shall be reinstated for an additional one year period, commencing with the date of acceptance of such corrected Work. Contractor shall perform such tests as the City may require to verify that any corrective actions, including, without limitation, redesign, repairs, and replacements comply with the requirements of the Contract. All costs associated with such corrective actions and testing, including the removal, replacement, and reinstatement of equipment and materials necessary to gain access, shall be the sole responsibility of Contractor. All warranties and guarantees of subcontractors, suppliers and manufacturers with respect to any portion of the Work, whether express or implied, are deemed to be obtained by Contractor for the benefit of the City, regardless of whether or not such warranties and guarantees have been transferred or assigned to the City by separate agreement and Contractor agrees to enforce such warranties and guarantees, if necessary, on behalf of the City. In the event that Contractor fails to perform its obligations under this Section, or under any other warranty or guaranty under this Contract, to the reasonable satisfaction of the City, the City shall have the right to correct and replace any defective or nonconforming Work and any work damaged by such work or the replacement or correction thereof at Contractor's sole expense. Contractor shall be obligated to fully reimburse the City for any expenses incurred hereunder upon demand.

3.16 Employee/Labor Certifications.

3.16.1 Contractor's Labor Certification. By its signature hereunder, Contractor certifies that he is aware of the provisions of Section 3700 of the California Labor Code which require every employer to be insured against liability for Worker's Compensation or to undertake self-insurance in accordance with the provisions of that Code, and agrees to comply with such provisions before commencing the performance of the Work. A certification form for this purpose, which is attached to this Contract as Exhibit "D" and incorporated herein by reference, shall be executed simultaneously with this Contract.

3.16.2 Equal Opportunity Employment. Contractor represents that it is an equal opportunity employer and that it shall not discriminate against any employee or applicant for employment because of race, religion, color, national origin, ancestry, sex, age or other interests protected by the State or Federal Constitutions. Such non-discrimination shall include, but not be limited to, all activities related to initial employment, upgrading, demotion, transfer, recruitment or recruitment advertising, layoff or termination.

3.16.3 Verification of Employment Eligibility. By executing this Contract, Contractor verifies that it fully complies with all requirements and restrictions of state and federal law respecting the employment of undocumented aliens, including, but not limited to, the Immigration Reform and Control Act of 1986, as may be amended from time to time, and shall require all subcontractors and sub-subcontractors to comply with the same.

### 3.17 General Provisions.

3.17.1 City's Representative. The City hereby designates the General Manager, or his or her designee, to act as its representative for the performance of this Contract ("City's Representative"). City's Representative shall have the power to act on behalf of the City for all purposes under this Contract. Contractor shall not accept direction or orders from any person other than the City's Representative or his or her designee.

3.17.2 Contractor's Representative. Before starting the Work, Contractor shall submit in writing the name, qualifications and experience of its proposed representative who shall be subject to the review and approval of the City ("Contractor's Representative"). Following approval by the City, Contractor's Representative shall have full authority to represent and act on behalf of Contractor for all purposes under this Contract. Contractor's Representative shall supervise and direct the Work, using his best skill and attention, and shall be responsible for all construction means, methods, techniques, sequences and procedures and for the satisfactory coordination of all portions of the Work under this Contract. Contractor's Representative shall devote full time to the Project and either he or his designee, who shall be acceptable to the City, shall be present at the Work site at all times that any Work is in progress and at any time that any employee or subcontractor of Contractor is present at the Work site. Arrangements for responsible supervision, acceptable to the City, shall be made for emergency Work which may be required. Should Contractor desire to change its Contractor's Representative, Contractor shall provide the information specified above and obtain the City's written approval.

3.17.3 Termination. This Contract may be terminated by City at any time, either with or without cause, by giving Contractor three (3) days advance written notice. In the event of termination by City for any reason other than the fault of Contractor, City shall pay Contractor for all Work performed up to that time as provided herein. In the event of breach of the Contract by Contractor, City may terminate the Contract immediately without notice, may reduce payment to Contractor in the amount necessary to offset City's resulting damages, and may pursue any other available recourse against Contractor. Contractor may not terminate this Contract except

for cause. In the event this Contract is terminated in whole or in part as provided, City may procure, upon such terms and in such manner as it may determine appropriate, services similar to those terminated. Further, if this Contract is terminated as provided, City may require Contractor to provide all finished or unfinished documents, data, diagrams, drawings, materials or other matter prepared or built by Contractor in connection with its performance of this Contract. City shall not be liable for any costs other than the charges or portions thereof which are specified herein. Contractor shall not be entitled to payment for unperformed Work including, without limitation, any overhead and profit on the portion of the Work that is terminated and shall not be entitled to damages or compensation of any kind or nature for termination of Work.

3.17.4 Contract Interpretation. Should any question arise regarding the meaning or import of any of the provisions of this Contract or written or oral instructions from City, the matter shall be referred to City's Representative, whose decision shall be binding upon Contractor.

3.17.5 Anti-Trust Claims. This provision shall be operative if this Contract is applicable to California Public Contract Code Section 7103.5. In entering into this Contract to supply goods, services or materials, Contractor hereby offers and agrees to assign to the City all rights, title, and interest in and to all causes of action it may have under Section 4 of the Clayton Act (15 U.S.C. Section 15) or under the Cartwright Act (Chapter 2, commencing with Section 16700, of Part 2 of Division 7 of the Business and Professions Code) arising from purchases of goods, services, or materials pursuant to the Contract. This assignment shall be made and become effective at the time the City tender final payment to Contractor, without further acknowledgment by the Parties.

3.17.6 Notices. All notices hereunder and communications regarding interpretation of the terms of the Contract or changes thereto shall be provided by the mailing thereof by registered or certified mail, return receipt requested, postage prepaid and addressed as follows:

**CONTRACTOR:**

Grbcon Incorporated  
5114 Elton Street  
Baldwin Park, CA 91706  
Attn: Kristion Grbavac

**CITY:**

City of Hermosa Beach  
1315 Valley Drive  
Hermosa Beach, CA 90254  
Attn: Heecheol Kwon

Any notice so given shall be considered received by the other Party three (3) days after deposit in the U.S. Mail as stated above and addressed to the Party at the above address. Actual notice shall be deemed adequate notice on the date actual notice occurred, regardless of the method of service.

3.17.7 Time of Essence. Time is of the essence in the performance of this Contract.

3.17.8 Assignment Forbidden. Contractor shall not, either voluntarily or by action of law, assign or transfer this Contract or any obligation, right, title or interest assumed by Contractor herein without the prior written consent of City. If Contractor attempts an assignment or transfer of this Contract or any obligation, right, title or interest herein, City may, at its option, terminate and revoke the Contract and shall thereupon be relieved from any and all obligations to Contractor or its assignee or transferee.

3.17.9 No Third Party Beneficiaries. There are no intended third party beneficiaries of any right or obligation assumed by the Parties.

3.17.10 Laws and Venue. This Contract shall be interpreted in accordance with the laws of the State of California. If any action is brought to interpret or enforce any term of this Contract, the action shall be brought in a state or federal court situated in the County of Los Angeles, State of California.

3.17.11 Counterparts. This Contract may be executed in counterparts, each of which shall constitute an original.

3.17.12 Successors. The Parties do for themselves, their heirs, executors, administrators, successors, and assigns agree to the full performance of all of the provisions contained in this Contract.

3.17.13 [Reserved]

3.17.14 Solicitation. Contractor maintains and warrants that it has not employed nor retained any company or person, other than a bona fide employee working solely for Contractor, to solicit or secure this Contract. Further, Contractor warrants that it has not paid nor has it agreed to pay any company or person, other than a bona fide employee working solely for Contractor, any fee, commission, percentage, brokerage fee, gift or other consideration contingent upon or resulting from the award or making of this Contract. For breach or violation of this warranty, City shall have the right to terminate this Contract without liability.

3.17.15 Conflict of Interest. Contractor maintains and warrants that it has not employed nor retained any company or person, other than a bona fide employee working solely for Contractor, to solicit or secure this Contract. Further, Contractor warrants that it has not paid nor has it agreed to pay any company or person, other than a bona fide employee working solely for Contractor, any fee, commission, percentage, brokerage fee, gift or other consideration contingent upon or resulting from the award or making of this Contract. For breach or violation of this warranty, City shall have the right to rescind this Contract without liability. For the term of this Contract, no official, officer or employee of City, during the term of his or her service with City, shall have any direct interest in this Contract, or obtain any present or anticipated material benefit arising therefrom. In addition, Contractor agrees to file, or to cause its employees or subcontractors to file, a Statement of Economic Interest with the City's Filing Officer as required under state law in the performance of the Work.

3.17.16 Certification of License.

3.17.16.1 Contractor certifies that as of the date of execution of this Contract, Contractor has a current contractor's license of the classification indicated below under Contractor's signature.

3.17.16.2 Contractors are required by law to be licensed and regulated by the Contractors' State License Board which has jurisdiction to investigate complaints against contractors if a complaint regarding a patent act or omission is filed within four (4) years of the date of the alleged violation. A complaint regarding a latent act or omission pertaining to structural defects must be filed within ten (10) years of the date of the alleged violation. Any questions concerning a contractor may be referred to the Registrar, Contractors' State License Board, P.O. Box 26000, Sacramento, California 95826.

3.17.17 Authority to Enter Contract. Each Party warrants that the individuals who have signed this Contract have the legal power, right and authority to make this Contract and bind each respective Party.

3.17.18 Entire Contract; Modification. This Contract contains the entire agreement of the Parties with respect to the subject matter hereof, and supersedes all prior negotiations, understandings or agreements. This Contract may only be modified by a writing signed by both Parties.

3.17.19 Non-Waiver. None of the provisions of this Contract shall be considered waived by either party, unless such waiver is specifically specified in writing.

3.17.20 City's Right to Employ Other Contractors. City reserves right to employ other contractors in connection with this Project or other projects.

**[SIGNATURES ON NEXT PAGE]**

**SIGNATURE PAGE FOR CONSTRUCTION CONTRACT  
BETWEEN THE CITY OF HERMOSA BEACH  
AND**

IN WITNESS WHEREOF, the Parties have entered into this Contract as of the 28<sup>th</sup> day of July, 2025.

CITY OF HERMOSA BEACH

GRBCON INCORPORATED

By: Steve Napolitano  
Steve Napolitano  
Interim City Manager

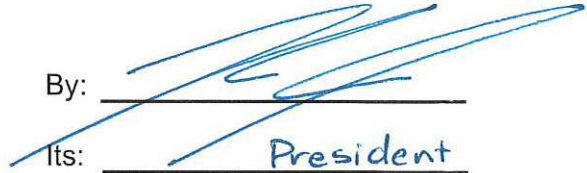
By:   
Its: President  
Printed Name: Kristian Girkawac

Approved as to Form:

By: Todd Leishman  
Todd Leishman  
Interim City Attorney

### ACKNOWLEDGMENT

A notary public or other officer completing this certificate verifies only the identity of the individual who signed the document to which this certificate is attached, and not the truthfulness, accuracy, or validity of that document.

State of California  
County of Los Angeles )

On July 29, 2025 before me, Brett Harper, Notary Public  
(insert name and title of the officer)

personally appeared Kristion Grbauer,  
who proved to me on the basis of satisfactory evidence to be the person(s) whose name(s) ~~is/are~~  
subscribed to the within instrument and acknowledged to me that ~~he/she/they~~ executed the same in  
~~his/her/their~~ authorized capacity(ies), and that by ~~his/her/their~~ signature(s) on the instrument the  
person(s), or the entity upon behalf of which the person(s) acted, executed the instrument.

I certify under PENALTY OF PERJURY under the laws of the State of California that the foregoing paragraph is true and correct.

WITNESS my hand and official seal.

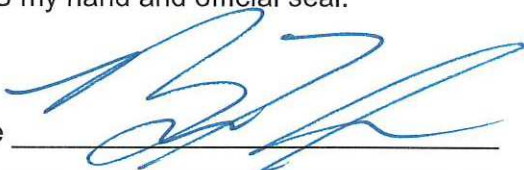
Signature  (Seal)

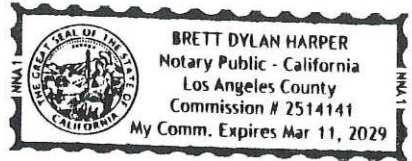

**EXHIBIT "A"**  
**SERVICES / SCHEDULE**

PLEASE REFER TO THE NEXT PAGE

# GRB CON I N C O R P O R A T E D

Bid Date: 7.17.2025

Re: City of Hermosa Beach – Valley Dr. Storm Drain

Bid Item	Description	Quantity	Unit of Measure	Unit Price	Extended Price
	Excavation & disposal of materials	20	CY	685.00	13,700.00
	Shoring as needed	1	LS	1,500.00	1,500.00
	Install 30' of 30" dual walled N12 pipe	30	LF	1,709.00	51,270.00
	Back fill with 1.5 sack slurry	20	CY	249.00	4,980.00
	Pour concrete collar	1	EA	3,750.00	3,750.00
	Provide temporary by pass of LA County well	1	LS	4,925.00	4,925.00
	Pave per Hermosa Beach #117	300	SF	80.00	24,000.00
<b>Total Bid Price \$104,125.00</b>					

Conditions: One Mobilization. 9am – 5pm Mon. to Fri. work hours. TC per WATCH manual

EXCLUDES: ARHM paving, concrete pavement intersections, full intersection resurfacing, noise abatement, slurry seal, traffic loops, by pass monitoring & maintenance, engineered traffic control plans, traffic loops, all testing, any & all permits.

If you have any questions, please feel free to call at 626-476-6084 or email [kgrbavac@grbcon.com](mailto:kgrbavac@grbcon.com)

5114 Elton Street, Baldwin Park, CA 91706 | Office: 626-699-2380 | Fax: 626-699-2457

Lic. No. 1012408 A | Exp: 3/31/26 | DIR No. 1000038691 | Exp: 6/30/24 | DGS SBE No. 2002710

**EXHIBIT "B"**  
**PLANS AND SPECIFICATIONS**

PLEASE REFER TO THE NEXT PAGE

## Emergency Storm Drainpipe Replacement and Sinkhole Repair on Valley Drive

### SCOPE OF WORK

#### 1. GENERAL

The contractor shall provide all necessary labor, materials, equipment and incidentals required for the pipe replacement of approximately 30'-40' of storm drain line. This includes trench excavation & backfill, and pavement restoration as described herein. The Contractor is responsible for the full removal and replacement of the existing pipeline and shall take all the necessary steps to ensure that both pipe replacement and sinkhole repair work are in complete.

#### 2. SRANDARD SPECIFICATIONS AND DRAWING

The Standard Specifications for Public Works Construction (SPPWC), written and promulgated by the Southern California Chapter of the American Public Works Association and the Southern California Districts of the Associated General Contractors of California, shall be the Standard Specifications of the City. All work shall conform to the latest editions of SSPWC specifications and the Standard Plans for Public Works Construction (SPPWC), and **the plans issued by the City.**

#### 3. WORK DESCRIPTION

- Storm drain pipe shall be a 30" diameter ADS N-12 dual wall HDPE pipe or on approved equivalent and approximately 30' – 40' length.
- City STD. plan# 117, trench section detail, pertains to the restoration of trench pavement only.
- Trench excavation and backfill, approximately 30' – 40' length
  - **Excavated Material:** All excavated material shall be removed and properly disposed of off-site
  - **Trech Width:** The trench width shall be the pipe diameter plus 36 inches on each side per plan.
  - **Backfill Material:** The trench backfill shall consist of 1.5 sack slurry cement up to the AC base course level
  - **Subgrade Preparation:** If the yielding subgrade conditions are encountered due to high moisture content, the yielding soil shall be over-excavated 12 inch minimum.
  - **Bedding Material:** Bedding shall consist of sand equivalent 30 material or ¾" max. crushed rock
- Trench Shoring and Safety Measures
  - All excavation work shall include appropriate trench shoring per Cal/OSHA requirements
  - Temporary steel plate covers shall be provided during and after construction as necessary
- Temporary Bypass

Due to the ongoing overflow from the LA County injection well, the contractor shall provide a temporary bypass system to manage the overflow during and after the construction. This system may include the use of sandbags or any other method subject to approval by the engineer.
- The exiting utility potholing and striping restoration shall be included.

4. PERMIT AND ACCESS

The Contractor shall obtain all necessary permits and licenses for any work within the right of way. The right-of-way permit will be issued at no cost (no-fee permit).

5. TRAFFIC CONTROL

All traffic control shall be in accordance with the latest edition of the Work Area Traffic Control Handbook (WATCH) and City regulations and based on the speed limits posted in the work zones. Flagmen may be required in some locations. Additional local regulations shall have precedence.

6. CONTRACTORS REQUIREMENTS

The Contractor's supervisor(s) performing the work shall be qualified to perform the work and have a minimum of five (5) years' experience in utility pipeline construction and be able to communicate both verbally and in writing with City staff as well as with his crew. The Contractor's supervisor must demonstrate the capability to read, interpret and understand the Safety/OSHA requirements, City plans, drawings and specifications as necessary. All work and equipment utilized shall conform to FED-OSHA Title 8 Requirements, including, but not limited to work performed in confined spaces and/or gas hazardous environments.

7. PUBLIC RELATIONS

The contractor shall investigate any complaint which may concern, or be involved in, the performance of the work. The contractor shall report to the Director of Public Works, or designee, the following working day as to the action taken with reference to the complaint and, when necessary, complete a Service Request, which will remain on file at City Hall. Complaints received before noon shall be answered on the same day; complaints received after noon shall be answered the following day.

8. WORKING HOURS

Working hours are Monday – Friday, 9:00 AM to 5:00 PM.

9. WORKING DAYS

The Contractor shall complete the work within **FIVE (5)** working days after receiving the "Notice to Proceed".

10. EMERGENCY CALL BACK

The Contractor shall provide employees and equipment to respond to any after hour emergency. A 24-hour contact phone number shall be provided by the Contractor. The contractor must respond within 30 minutes after being contacted by the city. The contractor must mobilize and have the appropriate personnel and equipment in the City of Hermosa Beach within two (2) hours from when the emergency phone call was received.

## 11. INSURANCE

The contractor shall procure and maintain for the duration of the Agreement, and for 1 year thereafter, insurance against claims for injuries to persons or damages to property which may arise from or in connection with the performance of the work hereunder by the CONTRACTOR, its agents, representatives, employees, or subcontractors.

a. Minimum Scope and Limit of Insurance. Coverage shall be at least as broad as:

- i. Commercial General Liability (CGL): Insurance Services Office (ISO) Form CG 00 01 covering CGL on an "occurrence" basis, including products and completed operations, property damage, bodily injury and personal & advertising injury with limits no less than \$5,000,000 per occurrence. If a general aggregate limit applies, either the general aggregate limit shall apply separately to this project/location (ISO CG 25 03 or 25 04) or the general aggregate limit shall be twice the required occurrence limit.
- ii. Automobile Liability: Insurance Services Office Form CA 0001 covering Code 1 (any auto), with limits no less than \$5,000,000 per accident for bodily injury and property damage.
- iii. Workers' Compensation insurance as required by the State of California, with Statutory Limits, and Employers' Liability insurance with a limit of no less than \$1,000,000 per accident for bodily injury or disease.
- iv. Professional Liability (if Design/Build), with limits no less than \$2,000,000 per occurrence or claim, and \$2,000,000 policy aggregate.
- v. Contractors' Pollution Legal Liability and/or Asbestos Legal Liability and/or Errors and Omissions (if project involves environmental hazards) with limits no less than \$1,000,000 per occurrence or claim, and \$2,000,000 policy aggregate.
- vi. If the Contractor maintains broader coverage and/or higher limits than the minimums shown above, the CITY requires and shall be entitled to the broader coverage and/or the higher limits maintained by CONTRACTOR. Any available insurance proceeds in excess of the specified minimum limits of insurance and coverage shall be available to the CITY.

b. Self-Insured Retentions. Self-insured retentions must be declared to and approved by the CITY. At the option of the CITY, either: the CONTRACTOR shall obtain coverage to reduce or eliminate such self-insured retentions as respects the CITY, its officers, officials, employees, and volunteers; or the CONTRACTOR shall provide a financial guarantee satisfactory to the CITY guaranteeing payment of losses and related investigations, claim administration, and defense expenses. The policy language shall provide, or be endorsed to provide, that the self-insured retention may be satisfied by either the named insured or CITY.

c. Other Insurance Provisions. The insurance policies are to contain, or be endorsed to contain, the following provisions:

- i. The CITY, its officers, officials, employees, and volunteers are to be covered as additional insureds on the CGL policy with respect to liability arising out of work or operations performed by or on behalf of the

CONTRACTOR including materials, parts, or equipment furnished in connection with such work or operations and automobiles owned, leased, hired, or borrowed by or on behalf of the CONTRACTOR. General liability coverage can be provided in the form of an endorsement to the CONTRACTOR's insurance (at least as broad as ISO Form CG 20 10, CG 11 85 or both CG 20 10, CG 20 26, CG 20 33, or CG 20 38; and CG 20 37 forms if later revisions used).

- ii. For any claims related to this project, the CONTRACTOR's insurance coverage shall be primary insurance coverage at least as broad as ISO CG 20 01 04 13 as respects the CITY, its officers, officials, employees, and volunteers. Any insurance or self-insurance maintained by the CITY, its officers, officials, employees, or volunteers shall be excess of the CONTRACTOR's insurance and shall not contribute with it.
  - iii. Each insurance policy required by this clause shall provide that coverage shall not be canceled, except with notice to the CITY.
- d. Builder's Risk (Course of Construction) Insurance.
- i. CONTRACTOR may submit evidence of Builder's Risk insurance in the form of Course of Construction coverage. Such coverage shall name the CITY as a loss payee as their interest may appear.
  - ii. If the Project does not involve new or major reconstruction, at the option of the CITY, an Installation Floater may be acceptable. For such projects, a Property Installation Floater shall be obtained that provides for the improvement, remodel, modification, alteration, conversion or adjustment to existing buildings, structures, processes, machinery, and equipment. The Property Installation Floater shall provide property damage coverage for any building, structure, machinery or equipment damaged, impaired, broken, or destroyed during the performance of the Work, including during transit, installation, and testing at the CITY's site.
- e. Claims Made Policies. If any coverage required is written on a claims-made coverage form:
- i. The retroactive date must be shown, and this date must be before the execution date of the Contract or the beginning of Contract work.
  - ii. Insurance must be maintained and evidence of insurance must be provided for at least five (5) years after completion of Contract work.
  - iii. If coverage is cancelled or non-renewed, and not replaced with another claims-made policy form with a retroactive date prior to the Contract effective, or start of work date, the CONTRACTOR must purchase extended reporting period coverage for a minimum of five (5) years after completion of Contract work.
  - iv. A copy of the claims reporting requirements must be submitted to the CITY for review.

- v. If the services involve lead-based paint or asbestos identification/remediation, the Contractors Pollution Liability policy shall not contain lead-based paint or asbestos exclusions. If the services involve mold identification/remediation, the Contractors Pollution Liability policy shall not contain a mold exclusion, and the definition of Pollution shall include microbial matter, including mold.
- f. Acceptability of Insurers. Insurance is to be placed with insurers authorized to conduct business in the state with a current A.M. Best rating of no less than A: VII, unless otherwise acceptable to the CITY.
- g. Waiver of Subrogation. CONTRACTOR hereby agrees to waive rights of subrogation which any insurer of CONTRACTOR may acquire from CONTRACTOR by virtue of the payment of any loss. CONTRACTOR agrees to obtain any endorsement that may be necessary to affect this waiver of subrogation. The Workers' Compensation policy shall be endorsed with a waiver of subrogation in favor of the CITY for all work performed by the CONTRACTOR, its employees, agents and subcontractors.
- h. Verification of Coverage. CONTRACTOR shall furnish the CITY with original Certificates of Insurance including all required amendatory endorsements (or copies of the applicable policy language effecting coverage required by this clause) and a copy of the Declarations and Endorsement Page of the CGL policy listing all policy endorsements to CITY before work begins. However, failure to obtain the required documents prior to the work beginning shall not waive the CONTRACTOR's obligation to provide them. The CITY reserves the right to require complete, certified copies of all required insurance policies, including endorsements, required by these specifications, at any time.
- i. Subcontractors. CONTRACTOR shall require and verify that all subcontractors maintain insurance meeting all requirements stated herein, and CONTRACTOR shall ensure that CITY is an additional insured on insurance required from subcontractors. For CGL coverage, subcontractors shall provide coverage with a form at least as broad as CG 20 38 04 13.
- j. Special Risks or Circumstances. CITY reserves the right to modify these requirements, including limits, based on the nature of the risk, prior experience, insurer, coverage, or other circumstances.

## 12. Bond

Performance and payment bonds are required each in an amount equal to one hundred percent (100%) of the contract price.

## 13. Payment

Payment for this work shall be made on a lump sum basis and shall include furnishing all labor, materials, tools, equipment, transportation, mobilization, clearing and grubbing, traffic control, BMP implementation, USA marking, potholing, striping and pavement restoration, utility coordination with the relevant agencies, distribution of construction notice material and all other incidental work necessary to complete and in place, as specified in this Scope of Work, the Plans and the Contract Documents.

**Site Photos**



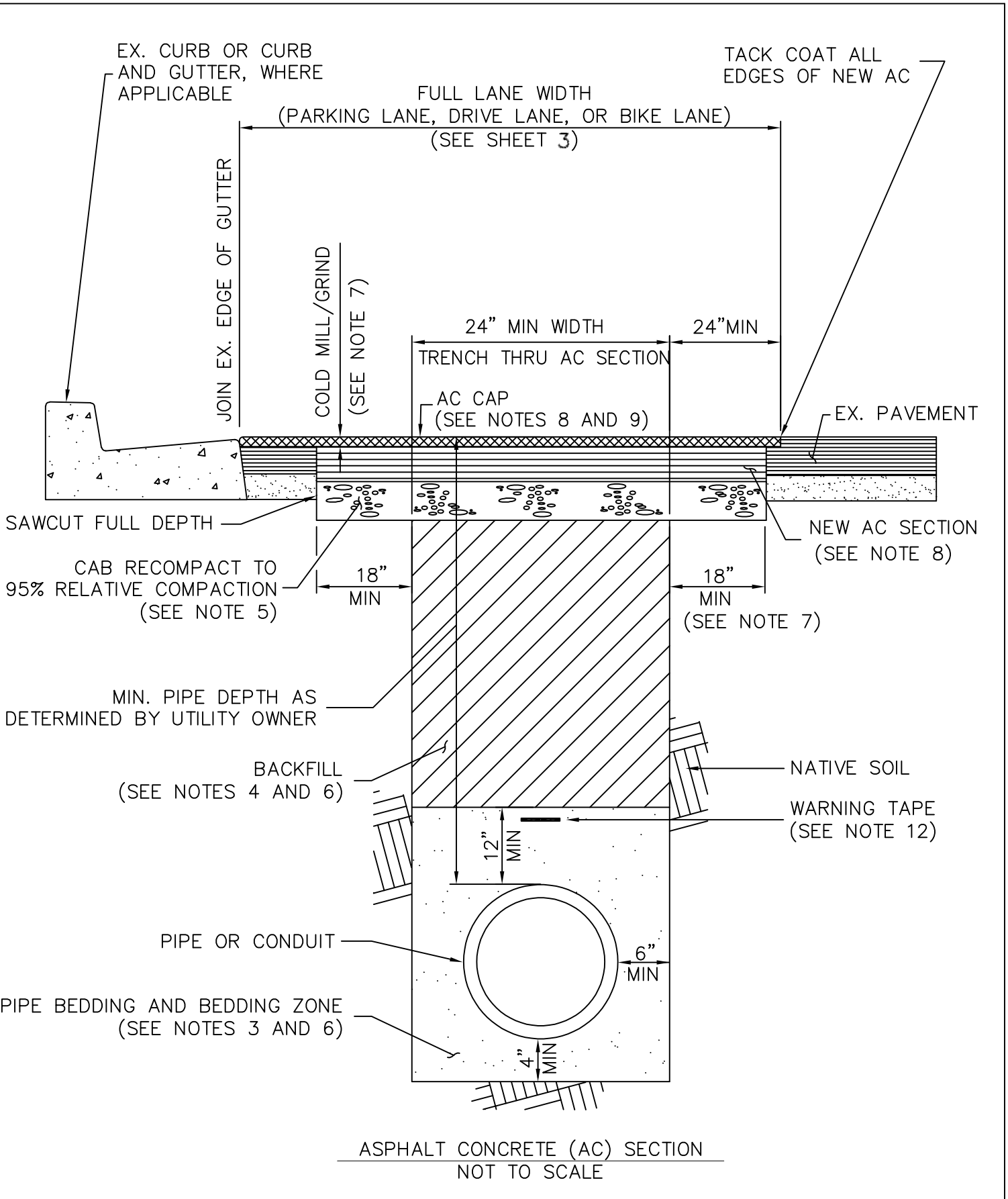



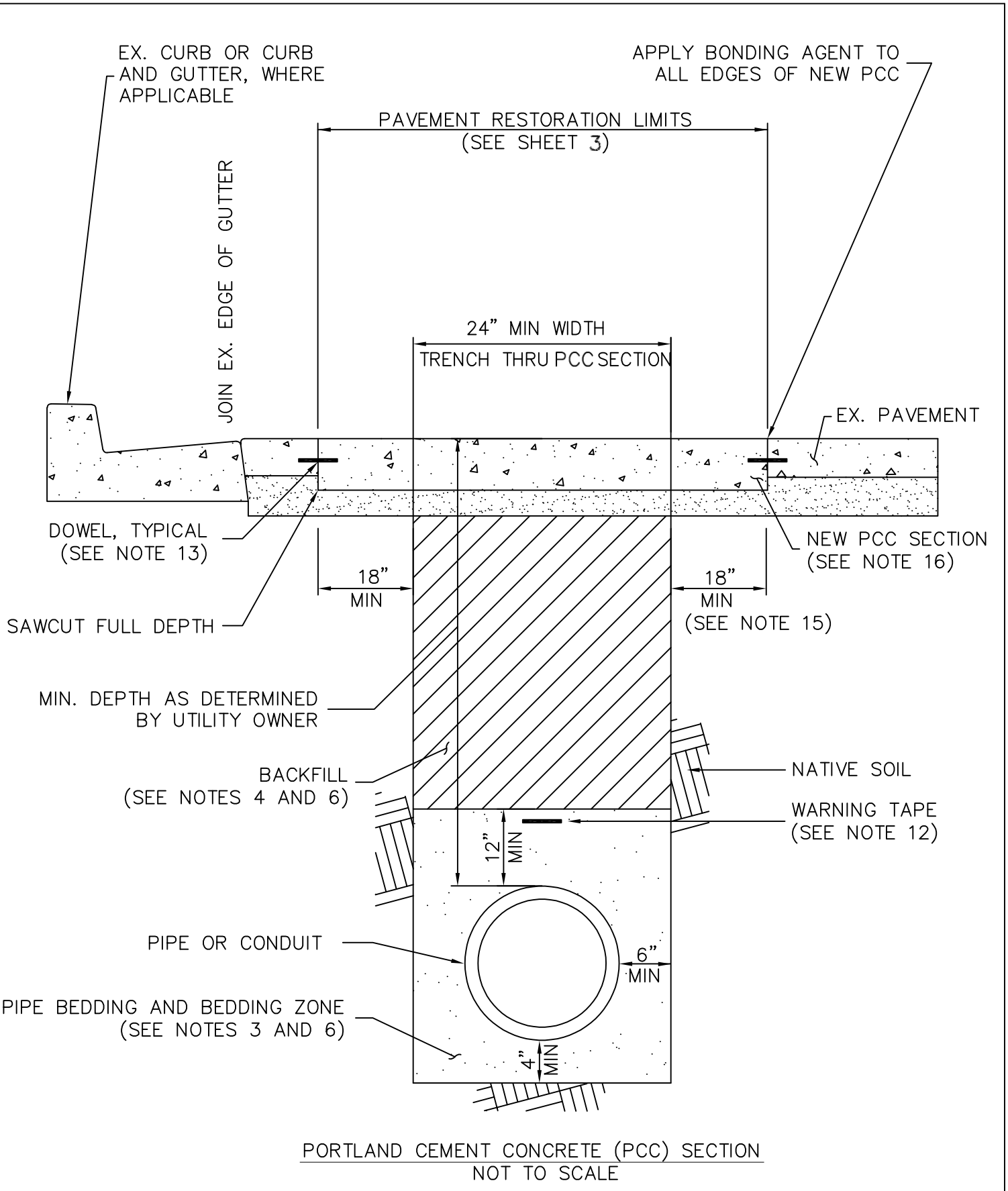

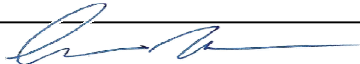
<b>CITY OF HERMOSA BEACH</b> DEPARTMENT OF PUBLIC WORKS		STANDARD PLAN NO. 117
ROADWAY UTILITY TRENCH DETAIL		
APPROVED BY: <u><i>Lucho Rodriguez</i></u> LUCHO RODRIGUEZ, CITY ENGINEER	DATE: <u>8-3-23</u>	SHEET 1 OF 5

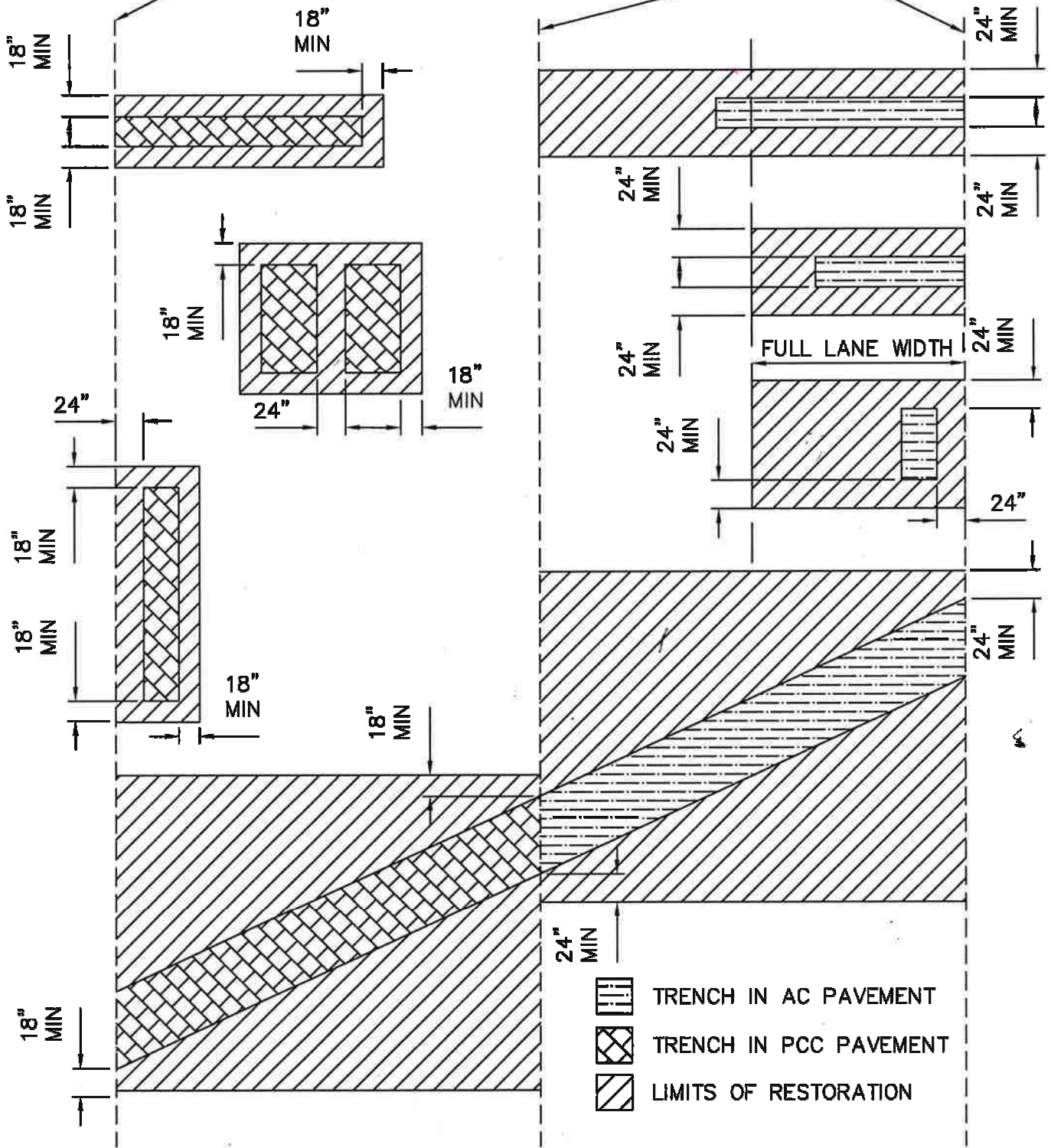

<b>CITY OF HERMOSA BEACH</b> DEPARTMENT OF PUBLIC WORKS		STANDARD PLAN NO. 117
ROADWAY UTILITY TRENCH DETAIL		
APPROVED BY:  LUCHO RODRIGUEZ, CITY ENGINEER	DATE: <u>8-3-23</u>	SHEET 2 OF 5

PAVEMENT EDGE (CURB, GUTTER, MEDIAN, PCC PAVEMENT JOINT, ETC.)



-  TRENCH IN AC PAVEMENT
-  TRENCH IN PCC PAVEMENT
-  LIMITS OF RESTORATION

RESTORATION LIMITS (AC AND PCC)  
NOT TO SCALE

<b>CITY OF HERMOSA BEACH</b> DEPARTMENT OF PUBLIC WORKS		STANDARD PLAN NO. 117
ROADWAY UTILITY TRENCH DETAIL		
APPROVED BY: 	DATE: <u>10.12.23</u>	SHEET 3 OF 5
LUCHO RODRIGUEZ, CITY ENGINEER		

NOTES:

1. STREETS/ALLEYS SLURRY SEALED, RESURFACED, OR CONSTRUCTED WITHIN 5 YEARS SHALL BE FINISHED WITH SLURRY SEAL TO A MINIMUM OF HALF OF THE ROADWAY WIDTH AS DETERMINED BY THE CITY.
2. IF THE UTILITY TRENCH IS WITHIN 2 FEET OF CURB AND GUTTER, CURB, ANOTHER REPAIR, AND/OR JOINT IN THE PAVEMENT, THE AC OR PCC BETWEEN SHALL BE REMOVED AT FULL DEPTH AND RECONSTRUCTED PER NOTE 8 OR 16.
3. BEDDING MATERIAL SHALL BE WET SAND OR NATIVE FREE-DRAINING GRANULAR MATERIAL CONFORMING TO SSPWC SECTION 306-6.
4. BACKFILL ABOVE BEDDING ZONE AND BELOW BASE SECTION SHALL BE NATIVE OR APPROVED IMPORT, COMPACTED TO A MINIMUM 90% RELATIVE COMPACTION, OR MINIMUM 1-SACK SAND CEMENT SLURRY AS APPROVED BY THE CITY.
5. A MINIMUM OF 6 INCHES BELOW THE AC SECTION SHALL BE CLASS II CRUSHED AGGREGATE BASE (CAB) COMPACTED TO A MINIMUM OF 95% RELATIVE COMPACTION.
6. THE CONTRACTOR IS RESPONSIBLE TO PROVIDE COMPACTION TESTING AS NEEDED BY A QUALIFIED SOILS/DEPUTY INSPECTOR FOR EVIDENCE OF PROPER COMPACTION ACHIEVED. COMPACTION TESTS SHALL BE PERFORMED AT MINIMUM INTERVALS OF TWO VERTICAL FEET AND 50 LINEAR FEET OR AS DIRECTED BY THE CITY PRIOR TO AC PAVING. JETTING IS PERMITTED WHEN APPROVED BY THE CITY AND CONFORMING TO SSPWC 306-12.4.
7. UPON COMPLETION OF BACKFILL, EXISTING AC SHALL BE SAW-CUT AT FULL DEPTH A MINIMUM OF 18 INCHES OUTSIDE TRENCH FOR FULL DEPTH RECONSTRUCTION OR AS DIRECTED BY CITY. THE EXISTING AC SHALL BE COLD PLANED (2 INCHES MIN. DEPTH) THE FULL WIDTH OF THE TRAFFIC LANE(S) (VEHICLE AND/OR BIKE) IMPACTED BY THE TRENCH.
8. AC SHALL BE REPLACED WITH C2-PG 64-10, 3/4 INCH BASE COURSE AND CAPPED WITH A MINIMUM OF 2 INCHES OF 1/2 INCH FINE COURSE AC. THICKNESS OF NEW AC SHALL BE A MINIMUM OF 5 INCHES OR 1 INCH GREATER THAN EXISTING, WHICHEVER IS GREATER.
9. AC CAP SHALL BE FINISHED FLUSH WITH EXISTING AC AND MATCH EXISTING PAVEMENT SLOPE, PROVIDING A SMOOTH SURFACE PER SSPWC SECTION 302-5. PAVEMENT FINISH SURFACE SHALL BE SUBJECT TO ACCEPTANCE BY THE PUBLIC WORKS INSPECTOR.
10. THE CONTRACTOR SHALL REPLACE TRAFFIC STRIPING, PAVEMENT MARKINGS, AND CURB MARKINGS REMOVED OR DAMAGED BY THE WORK WITH LIKE KIND MATERIALS TO MATCH EXISTING STRIPING.
11. TRENCH REPAIR MUST BE UNIFORM AND SQUARE. ZIG ZAG TRENCHES ARE NOT ALLOWED.
12. PLACE UNDERGROUND WARNING TAPE PER APWA UNIFORM COLOR CODE. USE 3 INCH WIDE DETECTABLE WARNING TAPE FOR PIPES AT DEPTH UP TO 24 INCHES AND 6 INCH WIDE DETECTABLE WARNING TAPE FOR PIPES AT DEPTH BETWEEN 24 INCHES AND 36 INCHES. FOR PIPES AT DEPTH GREATER THAN 36 INCHES, USE UNDETECTABLE WARNING TAPE.

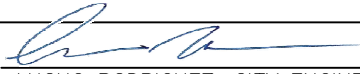
	<b>CITY OF HERMOSA BEACH</b> DEPARTMENT OF PUBLIC WORKS	STANDARD PLAN NO.
	ROADWAY UTILITY TRENCH DETAIL	117
	APPROVED BY:  _____ LUCHO RODRIGUEZ, CITY ENGINEER	DATE: <u>8-3-23</u> SHEET 4 OF 5

NOTES:

13. CONCRETE PAVEMENT RESTORATION SHALL BE DOWELED TO EXISTING CONCRETE PAVEMENT WITH #4 DOWELS AT 16 INCHES O.C. WITH APPROVED EPOXY. MINIMUM EMBEDMENT IS 4 INCHES.
14. FOR CONCRETE PAVEMENT RESTORATION, APPLY BONDING AGENT TO ALL EXISTING EXPOSED CONCRETE SURFACES PRIOR TO POURING FRESH CONCRETE. BONDING AGENT SHALL BE SIKA-AMRATEC-110EPOCEM ADHESIVE OR APPROVED EQUAL. SURFACES TO RECEIVE BONDING AGENT SHALL BE CLEAN AND FREE OF DIRT AND OTHER LOOSE MATERIALS.
15. UPON COMPLETION OF BACKFILL, EXISTING PCC SHALL BE SAW-CUT AT FULL DEPTH A MINIMUM OF 18 INCHES OUTSIDE TRENCH FOR FULL DEPTH RECONSTRUCTION OR AS DIRECTED BY CITY. SAWCUTTING IS REQUIRED AROUND THE PERIMETER OF THE FINAL EDGE OF ALL EXCAVATIONS TO PROVIDE CLEAN, VERTICAL LINES.
16. NEW PCC PAVEMENT SHALL BE 560-C-3250 OR HIGHER. THICKNESS OF NEW PCC SHALL BE A MINIMUM OF 6 INCHES OR 1 INCH GREATER THAN EXISTING, WHICHEVER IS GREATER.
17. PCC SHALL BE FINISHED FLUSH WITH EXISTING PCC AND MATCH EXISTING PAVEMENT SLOPE, PROVIDING A SMOOTH SURFACE PER SSPWC SECTION 302-6. PAVEMENT FINISH SURFACE SHALL BE SUBJECT TO ACCEPTANCE BY THE PUBLIC WORKS INSPECTOR.

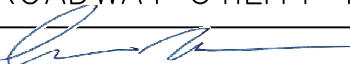
	<b>CITY OF HERMOSA BEACH</b> DEPARTMENT OF PUBLIC WORKS	STANDARD PLAN NO. 117
	ROADWAY UTILITY TRENCH DETAIL	
	APPROVED BY:  _____ LUCHO RODRIGUEZ, CITY ENGINEER	DATE: <u>8-3-23</u>
	SHEET 5 OF 5	

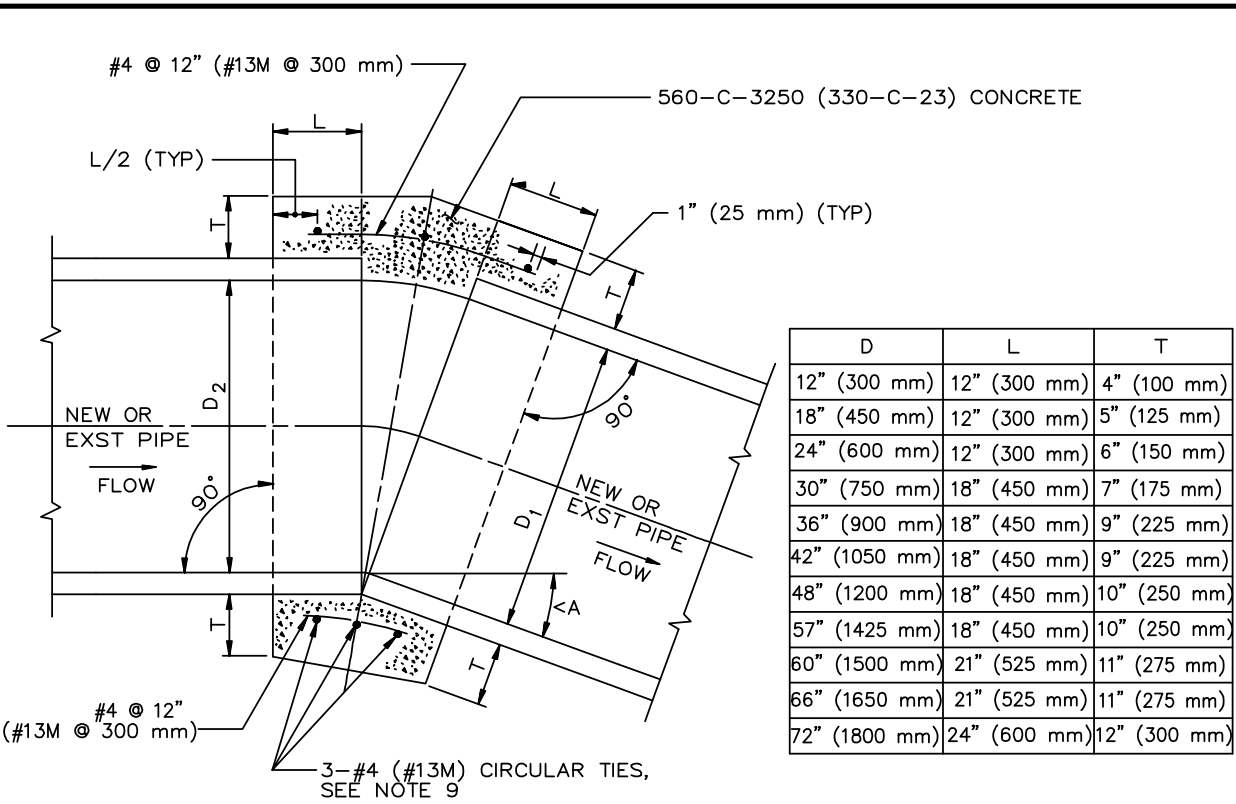

D	L	T
12" (300 mm)	12" (300 mm)	4" (100 mm)
18" (450 mm)	12" (300 mm)	5" (125 mm)
24" (600 mm)	12" (300 mm)	6" (150 mm)
30" (750 mm)	18" (450 mm)	7" (175 mm)
36" (900 mm)	18" (450 mm)	9" (225 mm)
42" (1050 mm)	18" (450 mm)	9" (225 mm)
48" (1200 mm)	18" (450 mm)	10" (250 mm)
57" (1425 mm)	18" (450 mm)	10" (250 mm)
60" (1500 mm)	21" (525 mm)	11" (275 mm)
66" (1650 mm)	21" (525 mm)	11" (275 mm)
72" (1800 mm)	24" (600 mm)	12" (300 mm)

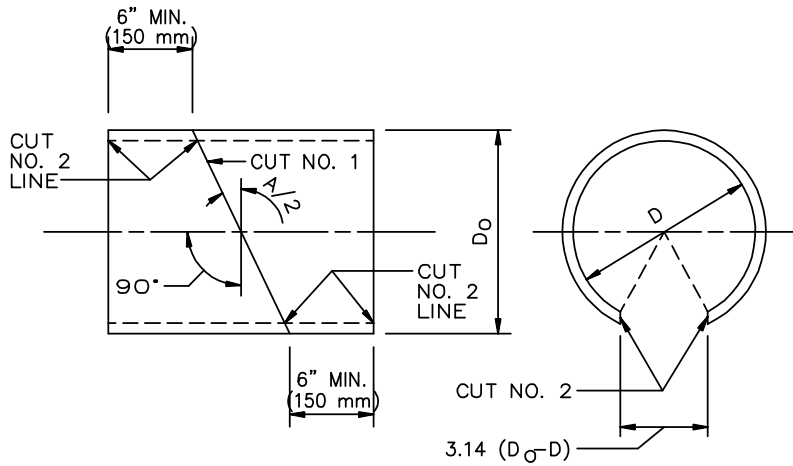

**DETAIL "A" (SEE NOTE 10)**  
SONO-TUBE, OR EQUAL, INTERIOR FORM

CUT NO. 1: SAW THE TUBE AT AN ANGLE OF A/2 WITH THE TRANSVERSE PLANE. REVERSE ONE SECTION AND TAPE BOTH SECTIONS TOGETHER FORMING THE DEFLECTION ANGLE A.  
 CUT NO. 2: SAW THE TUBE LONGITUDINALLY REMOVING A STRIP 3.14 (D<sub>0</sub>-D) WIDE ON THE SIDE OPPOSITE THE OPEN JOINT. BEND THE ENDS OF THE CUT TOGETHER AND INSERT THE TUBE IN THE PIPE.

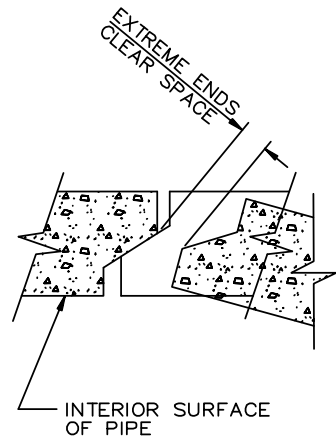

**DETAIL "B"**  
TYPICAL JOINT FOR REINFORCED CONCRETE PIPE

STANDARD PLANS FOR PUBLIC WORKS CONSTRUCTION		
PROMULGATED BY THE PUBLIC WORKS STANDARDS INC. GREENBOOK COMMITTEE 1992 REV. 1996, 1997, 1999, 2009	<h2 style="margin: 0;">CONCRETE COLLAR FOR RCP</h2> <h1 style="margin: 0;">12" (300 mm) THROUGH 72" (1800 mm)</h1> <p style="margin: 0; font-size: small;">USE WITH STANDARD SPECIFICATIONS FOR PUBLIC WORKS CONSTRUCTION</p>	STANDARD PLAN <h1 style="margin: 0;">380-4</h1> SHEET 1 OF 2

NOTES

1. A CONCRETE COLLAR IS REQUIRED WHERE THE CHANGE IN GRADE EXCEEDS 10%.
2. FOR CURVE JOINTS (SEE DETAIL B, SHEET 1)  
 IF THE EXTREME ENDS OF THE PIPE LEAVE A CLEAR SPACE THAT IS GREATER THAN 1" (25 mm), BUT IS LESS THAN 3" (75 mm) A CONCRETE COVER IS REQUIRED IN ACCORDANCE WITH SSPWC 306-1.2.4.  
 IF THE EXTREME ENDS OF THE PIPE LEAVE A CLEAR SPACE THAT IS EQUAL TO OR GREATER THAN 3" (75 mm), BUT LESS THAN 6" (150 mm), A CONCRETE COLLAR IS REQUIRED. IF THE CLEAR SPACE IS 6" (150 mm) OR GREATER, A TRANSITION STRUCTURE IS REQUIRED.
3. CONCRETE COLLAR SHALL NOT BE USED FOR A SIZE CHANGE ON THE MAIN LINE.
4. CONNECTOR PIPES
  - A. WHERE PIPES OF DIFFERENT DIAMETERS ARE JOINED WITH A CONCRETE COLLAR, L AND T SHALL BE THOSE OF THE LARGER PIPE.  $D = D_1$  OR  $D_2$ , WHICHEVER IS GREATER.
  - B. WHEN  $D_1$  IS EQUAL TO OR LESS THAN  $D_2$ , JOIN INVERTS AND WHEN  $D_1$  IS GREATER THAN  $D_2$ , JOIN SOFFITS.
5. FOR PIPE LARGER THAN 72" (1800 mm) SPECIAL COLLAR DETAILS ARE REQUIRED.
6. FOR PIPE SIZE NOT LISTED USE NEXT SIZE LARGER.
7. REINFORCEMENT SHALL CONFORM TO ASTM A 615 (A 615 M) GRADE 40 (300).
8. WHERE REINFORCING IS REQUIRED THE DIAMETER OF THE CIRCULAR TIES SHALL BE  $D + (2 \times \text{WALL THICKNESS}) + T$ .
9. REINFORCING SHALL BE USED WHERE THE PIPE DIAMETER IS GREATER THAN 21" (525 mm) AND ON ALL PIPES WHERE THE SPACES BETWEEN THE EXTREME OUTER ENDS IS 3" (75 mm) OR LARGER.

CIRCULAR TIES:

PIPE DIAMETER	NO. OF CIRCULAR TIES
21" (525 mm) OR LESS	3
24" (600 mm) TO 30" (750 mm)	3
33" (825 mm) TO 57" (1425 mm)	4
60" (1500 mm) TO 72" (1800 mm)	5

WHERE THE SPACE BETWEEN PIPE ENDS EXCEEDS 3" (75 mm), THE NUMBER OF CIRCULAR TIES SHALL BE INCREASED TO MAINTAIN AN APPROXIMATE SPACING OF 6" (150 mm) O.C.

10. WHERE THE PIPE IS 21" (525 mm) OR LESS IN DIAMETER AN INTERIOR FORM OF UNSEALED SONO-TUBE OR EQUAL SHALL BE USED TO PROVIDE A SMOOTH INTERIOR JOINT. THE PAPER FORM MAY BE LEFT IN PLACE (SEE DETAIL A). WHEN THE PIPE IS 24" (600 mm) OR LARGER A REMOVABLE INTERIOR FORM SHALL BE USED OR THE INTERIOR JOINT SHALL BE COMPLETELY FILLED WITH MORTAR AND NEATLY POINTED.

STANDARD PLANS FOR PUBLIC WORKS CONSTRUCTION

STANDARD PLAN

**CONCRETE COLLAR FOR RCP**  
**12" (300 mm) THROUGH 72" (1800 mm)**

**380-4**

SHEET 2 OF 2

**EXHIBIT "C"**

**SPECIAL CONDITIONS**

**ARTICLE 1. BONDS**

Within ten (10) calendar days from the date the Contractor is notified of award of the Contract, the Contractor shall deliver to the City four identical counterparts of the Performance Bond and Payment Bond on the forms supplied by the City and included as Exhibit "F" to the Contract. Failure to do so may, in the sole discretion of City, result in the forfeiture of Contractor's bid security. The surety supplying the bond must be an admitted surety insurer, as defined in Code of Civil Procedure Section 995.120, authorized to do business as such in the State of California and satisfactory to the City. The Performance Bond and the Payment Bond shall be for one hundred percent (100%) of the Total Contract Price.

**EXHIBIT "D"**

**CERTIFICATION  
LABOR CODE - SECTION 1861**

I, the undersigned Contractor, am aware of the provisions of Section 3700, et seq., of the California Labor Code which require every employer to be insured against liability for Worker's Compensation or to undertake self-insurance in accordance with the provisions of the Code, and I, the undersigned Contractor, agree to and will comply with such provisions before commencing the performance of the Work on this Contract.

**GRBCON INCORPORATED**

By:

  
\_\_\_\_\_  
Signature

Kristion Gurbavac  
Name (Print)

President  
Title (Print)

**EXHIBIT "E"**

**PUBLIC WORKS CONTRACTOR REGISTRATION CERTIFICATION**

Pursuant to Labor Code sections 1725.5 and 1771.1, all contractors and subcontractors that wish to bid on, be listed in a bid proposal, or enter into a contract to perform public work must be registered with the Department of Industrial Relations. See <http://www.dir.ca.gov/Public-Works/PublicWorks.html> for additional information.

No bid will be accepted nor any contract entered into without proof of the contractor's and subcontractors' current registration with the Department of Industrial Relations to perform public work.

Contractor hereby certifies that it is aware of the registration requirements set forth in Labor Code sections 1725.5 and 1771.1 and is currently registered as a contractor with the Department of Industrial Relations.<sup>1</sup>

Name of Contractor: GRBCON, Inc.

DIR Registration Number: 1000038691

DIR Registration Expiration: 6-30-2027

Small Project Exemption:  Yes or  No

Unless Contractor is exempt pursuant to the small project exemption, Contractor further acknowledges:

- Contractor shall maintain a current DIR registration for the duration of the project.
- Contractor shall include the requirements of Labor Code sections 1725.5 and 1771.1 in its contract with subcontractors and ensure that all subcontractors are registered at the time of bid opening and maintain registration status for the duration of the project.
- Failure to submit this form or comply with any of the above requirements may result in a finding that the bid is non-responsive.

Name of Contractor \_\_\_\_\_

Signature \_\_\_\_\_

Name and Title \_\_\_\_\_

Dated \_\_\_\_\_

<sup>1</sup> If the Project is exempt from the contractor registration requirements pursuant to the small project exemption under Labor Code Sections 1725.5 and 1771.1, please mark "Yes" in response to "Small Project Exemption."

**EXHIBIT "F"**

**FLEET COMPLIANCE CERTIFICATION**

The California Air Resources Board ("CARB") implemented amendments to the In-Use Off-Road Diesel-Fueled Fleets Regulations ("Regulation") which are effective on January 1, 2024 and apply broadly to all self-propelled off road diesel vehicles 25 horsepower or greater and other forms of equipment used in California. A copy of the Regulation is available at <https://ww2.arb.ca.gov/sites/default/files/barcu/regact/2022/off-roaddiesel/appa-1.pdf>. Bidders are required to comply with all CARB and Regulation requirements, including, without limitation, all applicable sections of the Regulation, as codified in Title 13 of the California Code of Regulations section 2449 *et seq.* throughout the term of the Project. Bidders must provide, with their Bid, copies of Bidder's and all listed subcontractors the most recent, valid Certificate of Reported Compliance ("CRC") issued by CARB. Failure to provide valid CRCs as required herein may render the Bid non-responsive.

**INSTRUCTIONS TO BIDDERS**

**COMPLIANCE WITH CARB REGULATIONS**

The City is a Public Works Awarding Body, as defined under Title 13 California Code of Regulations section 2449(c)(46). Accordingly, Bidders must submit, with their Bids, a valid Certificate of Reported Compliance ("CRC") for the Bidder's and its listed subcontractors fleet (including any applicable leased equipment or vehicles). Bidder must complete and submit the Fleet Compliance Certification, on the form included in the bid package. Failure to provide a valid CRC for the Bidder's fleet, and for the fleets of all listed subcontractors, or failure to complete the Fleet Compliance Certification, may render the Bid non-responsive.

**Fleet Compliance Certification.**

Bidder hereby acknowledges that they have reviewed the California Air Resources Board's policies, rules and regulations and are familiar with the requirements of Title 13, California Code of Regulations, Division 3, Chapter 9, effective on January 1, 2024 (the "Regulation"). Bidder hereby certifies, subject to penalty for perjury, that the option checked below relating to the Bidder's fleet, and/or that of their subcontractor(s) ("Fleet") is true and correct:

- The Fleet is subject to the requirements of the Regulation, and the appropriate Certificate(s) of Reported Compliance have been attached hereto.
- The Fleet is exempt from the Regulation under section 2449.1(f)(2), and a signed description of the subject vehicles, and reasoning for exemption has been attached hereto.
- Bidder and/or their subcontractor is unable to procure R99 or R100 renewable diesel fuel as defined in the Regulation pursuant to section 2449.1(f)(3). Bidder shall keep detailed records describing the normal refueling methods, their attempts to procure renewable diesel fuel and proof that shows they were not able to procure renewable diesel (i.e. third

party correspondence or vendor bids).

- The Fleet is exempt from the requirements of the Regulation pursuant to section 2449(i)(4) because this Project has been deemed an Emergency, as defined under section 2449(c)(18). Bidder shall only operate the exempted vehicles in the emergency situation and records of the exempted vehicles must be maintained, pursuant to section 2449(i)(4).
- The Fleet does not fall under the Regulation or are otherwise exempted and a detailed reasoning is attached hereto.

Name of Bidder: GRBCON, Inc

Signature: 

Name: Kristian Grbavac

Title: President

Date: 7.29.2025



California Environmental Protection Agency  
**Air Resources Board**

**January 1, 2025**

**CERTIFICATE OF REPORTED COMPLIANCE  
OFF-ROAD DIESEL VEHICLE REGULATION**

is issued to

**GRBCON, INC.**

This certificate indicates that the fleet listed above has reported off-road diesel vehicles to the California Air Resources Board and has certified they are in compliance with title 13 CCR, section 2449. All applicable vehicles owned by the individual, company, or agency must be reported and labeled, as specified in Section 2449, with all possible completeness, else this certificate is null and void. **Certificate expires 2/28/2026**

Jack Kitowski  
Chief, Mobile Source Control Division  
California Air Resources Board

Off-road Diesel Fleet Identification

**181147**

To verify the authenticity of this certificate, enter this number at  
[http://www.arb.ca.gov/doors/compliance\\_cert1.html](http://www.arb.ca.gov/doors/compliance_cert1.html)